

FIG. 1A

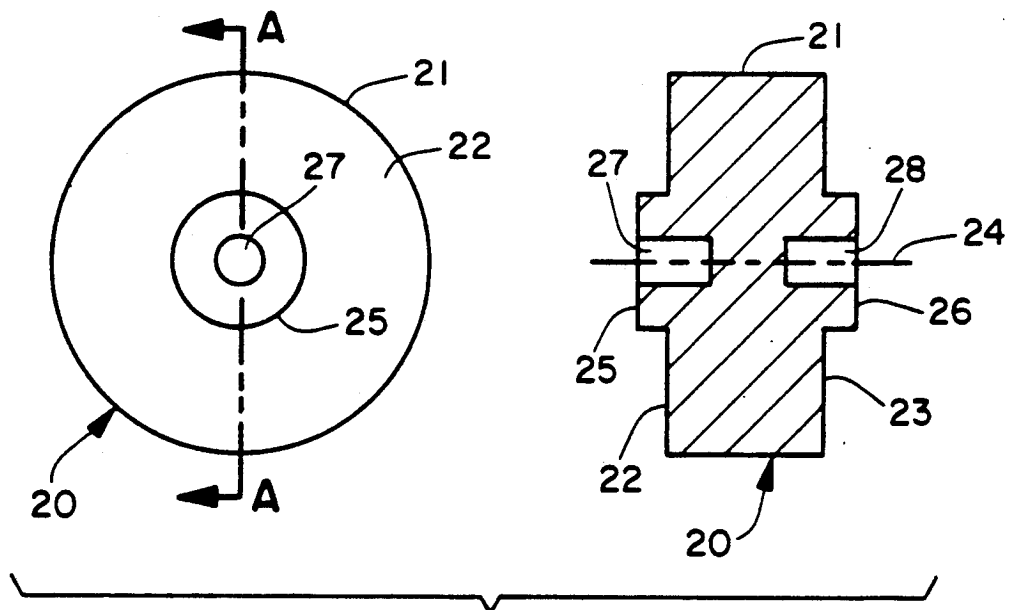

FIG. 2A