

MASTERSONIC[®]



MASTERSONIC[®]
MSG.1200.OF
ULTRASONIC POWER SUPPLY
MMM, Wideband Multifrequency Technology

SYSTEM OPERATION
MANUAL

PRELIMINARY

CONTENTS

| | |
|--|----|
| 1. INTRODUCTION | 4 |
| 1.1. FEATURES | 4 |
| 1.2. TECHNICAL CHARACTERISTICS OF MSG X00.OF | 5 |
| 1.3. SYSTEM SAFETY | 5 |
| | |
| 2. SYSTEM SET-UP | 7 |
| 2.1. INSTALLATION AND CONNECTION | 7 |
| 2.2. FACTORY SETTINGS AND INITIAL GENERATOR START UP | 12 |
| 2.3. CONTROL TERMINAL BLOCK | 13 |
| 2.4. CONTROL BLOCK | 16 |
| 2.5. CONTROL BOARD JUMPERS | 16 |
| 2.6. SWEEPING ADJUSTMENT | 18 |
| 2.7. MSG.1200.OF GENERATOR PARAMETERS | 20 |
| | |
| 3. FRONT PANEL | 21 |
| 3.1. YELLOW INDICATOR LIGHT | 21 |
| 3.2. GREEN INDICATOR LIGHT | 21 |
| 3.3. RED EXT. BLOCK INDICATOR LIGHT | 21 |
| 3.4. RED OVERVOLTAGE INDICATOR LIGHT | 21 |
| 3.5. INDUCTIVE COMPENSATION REGULATOR | 21 |
| | |
| 4. REMOTE CONTROL PANEL | 22 |
| 4.1. REMOTE CONTROL PANEL DESCRIPTION | 22 |
| 4.2. REMOTE CONTROL PANEL CONNECTION | 22 |
| 4.3. REMOTE CONTROL PANEL OPERATION | 22 |
| | |
| 5. PC SOFTWARE CONTROL OPTION | 25 |
| 5.1. PC AND CUSTOM SOFTWARE CONTROL DESCRIPTION | 25 |
| 5.2. PC GRAPHICAL USER INTERFACE WINDOW | 25 |
| 5.3. CUSTOM CONTROLLER OR SPECIAL PC COMMAND OPTIONS | 26 |
| | |
| 6. LIMITATION OF WARRANTY | 29 |
| | |
| 7. SERVICE | 30 |
| | |
| APPENDIX | 31 |

Dear Customer,

The **MASTERSONIC** program represents a brand new approach in **Sonic and Ultrasonic power supplies and equipment**.

The **MASTERSONIC power supply equipment** is based on **MMM Technology**, which produces high efficiency active power in wide-band sonic and ultrasonic vibrations. Wide-band sonic and ultrasonic energy (ranging in frequency from infrasonic up to the MHz domain) propagates through arbitrary shaped solid structures, heavy and very-thick-walls metal containers, pressurized reservoirs, very thick metal walls of autoclaves, etc. in many different mechanical structures and in liquids, such as ultrasonic cleaning systems. The secret to its application is a novel sonic / ultrasonic, multifrequency power supply (**MMM Technology**) that can initiate ringing and relaxing, modulated, multimode mechanical oscillations including harmonics and sub-harmonics. The system offers fine control and excellent repeatability from its programmable interface and produces high efficiency active power ranging from below 100 W up to many kW.

Multifrequency, Multimode, Modulated Sonic & Ultrasonic Vibrations (MMM Technology) can be excited in any heavy-duty conditions, producing pulse-repetitive, phase, frequency and amplitude-modulated bulk-wave-excitation covering and sweeping an extremely wide frequency band. Such sonic and ultrasonic driving creates uniform and homogenous distribution of acoustical activity on a surface and inside of the vibrating system, while avoiding the creation of stationary and standing waves, so that the whole vibrating system is fully agitated. Such multifrequency ultrasonic structural excitation is ideal for agitating arbitrary shaped liquid and solid masses at arbitrary distances and placed in open or pressurized vessels, containers, autoclaves, reservoirs and pipes, at any temperature, while maintaining optimum efficiency of electrical to acoustic energy transfer.

The oscillations of here-described sonic and ultrasonic source are not random - rather they follow a consistent pulse-repetitive pattern, being in the same time frequency, phase and amplitude-modulated by the control system. This avoids the creation of stationary or standing waves (typically produced by traditional ultrasonic systems operating at a single frequency) that generate regions of high and low acoustic activity. **MMM technology** provides great freedom of control, regulation and programming over all vibration, frequency and power parameters.

Fields of possible applications related to **MMM Technology** are: Advanced Ultrasonic Cleaning, Material Processing, Sonochemistry, Liquid Metals and Plastics treatment, Casting, Molding, Injection, Ultrasonically assisted sintering, Liquids Atomization, Liquids Mixing and Homogenization, Materials Testing, Accelerated Aging and Stress Release, Plastic and Metals Welding, etc.

In traditional ultrasonics technology, transducers have been designed to satisfy precise resonant conditions: In order to achieve maximal efficiency, all oscillating elements should operate on the same frequency. **MMM technology** can drive with high efficiency any complex mechanical system up to a mass of several tonnes, consisting of arbitrary resonating elements. **MMM technology**, instead of optimizing transducers to accept certain resonant frequency operation, optimizes the complex electrical driving (or signal shape) to be applicable to any specific oscillating structure, in a wide-band frequency domain, allowing mechanical designers to optimize their mechanical structures without limits.

1. INTRODUCTION

1.1. Features:

All MSG modular ultrasonic generators (MSG X00.OF) utilize the MMM Technology and are constructed with an open frame design intended for integration into Ultrasonic Systems providing appropriate housing and protection.

Presently available modules are made for driving the following piezoelectric loads:

- MSG 300.OF for driving 300W piezoelectric load;
- MSG 600.OF for driving 600W piezoelectric load;
- MSG 1200.OF for driving 1200W piezoelectric load



Fig. 1.1. MSG.1200.OF Generator Module and Accessories

The MSG 1200.OF system with optional accessories is shown on fig. 1.1. It consists of:

- Generator unit
- Optional Remote Control Panel for parameterization.
- Optional adapter for direct PC or PLC control

1. INTRODUCTION

1.2. Technical Characteristics of MSG1200.OF:

| Technical Characteristics | MSG 1200.OF |
|---------------------------------|------------------------|
| Power Supply Voltage | 230 V; 50/60 Hz |
| Max. Input Power | 1300 W |
| Output Frequency | 19.020kHz ÷ 46.728 kHz |
| Average Continuous Output Power | 1200 W |
| Pick Output (max. pulsed power) | 6000 W |
| Output HF Voltage | ~ 500 V-rms |
| Dimensions (h x w x d) | 230 x 160 x 370 |
| Weight | 4 kg |

1.3. System safety:

Read this manual thoroughly and follow all directions and instructions to assure maximum safety during operation.

- Installation of the MasterSonic (generator/power supply) and associated transducers, the “MasterSonic System”, is to be performed by qualified technical personnel only.
- The MasterSonic System is an electro-mechanical device that under certain circumstances could present an electrical shock hazard to the operator.
- The MasterSonic System should only be used and operated by properly trained and qualified technicians.
- Qualified technicians licensed by the manufacturer should only perform servicing of the MasterSonic System.
- Use of controls or adjustments or performance of procedures other than those specified herein may result in hazardous exposure to ultrasonic energy.
- To avoid electric shock, do not remove the case covers from the MasterSonic System. There are no user-serviceable parts inside any of these devices.
- Connecting the Generator unit to mains that supplies improper voltage may cause the Generator to malfunction or create a shock or fire hazard.
- Proper system grounding cannot be insured unless unit is connected to properly wired three prong 220 - 230 VAC single-phase outlet with a sufficient current rating.
- Do not remove the grounding prong on the line cord plug.

1. INTRODUCTION

- The Generator Electrical Supply cord should not be plugged into a device (e.g. “power strips”, “gang plugs”, etc.) other than an industrial grade wall socket. Such other use could cause significant changes in voltage that could result in an electrical fault indication. This condition may occur even though other equipment plugged into multi-outlet sockets continues to operate.
- Do not restrict airflow to the MasterSonic System by covering or enclosing in a sealed housing while in operation. Airflow must circulate through the unit during operation to facilitate proper cooling of electronic components.
- Do not place Generator on towel, foam or other soft surface since the material may block air vents. Blocking vents may cause Generator to overheat and malfunction or create a shock hazard.
- Do not expose or immerse the MasterSonic System or the transducer in water or liquids. The system is not sealed against liquids and exposure may result in damage to the equipment, create a shock hazard, or fire hazard.
- Due to the general operating principles of the MasterSonic System and ultrasonics, this equipment is not suitable for use in environments where danger of explosion exists.
- The Generator should not be turned on until the Transducer Cable has been connected to both the Generator and Transducer. Otherwise, damage to the Generator may result.
- When ultrasound output power is on, do not touch the transducer, booster, sonotrode, waveguide, or any device directly connected to these components; doing so may result in injury.
- Ear protection during operation of the system is highly recommended. Do not position the transducer, booster, sonotrode, waveguide, or any device directly connected to these components near the technician or operators ears. The operating frequency of the MasterSonic System is below, within, and above the range of human hearing, and emits acoustic energy. Do not activate the system if system components are within 4 feet (122 cm) of the ears of technician or operators.

2. SYSTEM SET-UP

2.1. Installation and connection.

MasterSonic open frame generator modules are designed for internal mounting in the control cabinets of Ultrasonic Systems. Such cabinets should be very well ventilated, protecting the generator module from excessive dust, moisture, and harmful chemical agents.

Before mounting or connecting the MSG.1200.OF generators make sure that all protection conditions are strictly observed and satisfied.

The installation and electrical connections of the generator should be performed by a qualified specialist in electronics who is experienced in Power Ultrasonics.

Fig. 2.1. depicts the main power supply schematic and the Acoustic Load Connections for the MSG.1200.OF.

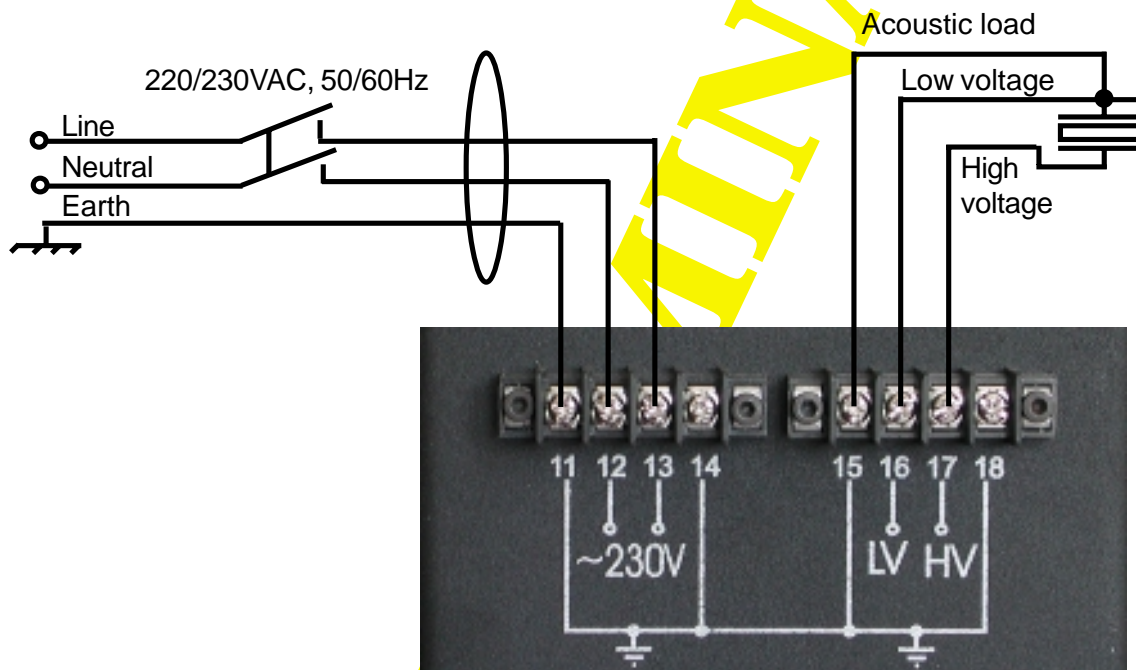

Fig. 2.1. Installation and connection of MSG1200.OF.

2. SYSTEM SET-UP

2.1.1. Mains Power Supply Connection

Using proper three-wire power supply cable, connect the MSG.1200.OF to the mains power line as follows:

- L1 – Line is connected to terminal 13;
- Neutral is connected to terminal 12;
- Ground is connected to terminal 11.

Note: MSG.1200.OF is designed as a component part for integration into Ultrasonic systems. Therefore it is not equipped with a Power Supply ON/OFF switch. Make sure the Ultrasonic System you are assembling is provided with such switch.

2.1.2. Acoustic Load Connection.

The acoustic load can be connected with two-wire or three-wire cable. For improved safety the manufacturer strongly recommends connecting the acoustic load using the three wire connection method.

As show in figure 2.1 above the 2-Pin terminal connector in the lower right side of the MSG.1200.OF terminals 17-HV (High Voltage) and 16-LV (Low Voltage) are used to supply ultrasonic power to the Acoustic Load (piezoelectric transducer).

- Terminal 17-HV is the high voltage ultrasonic signal output from the power transformer of the generator and should be connected to the Isolated Terminal of the transducer.
- Terminal 16-LV should be connected to the inductive compensation of the transducer and to the acoustic system grounding (transducer housing or acoustic load mass).

CAUTION: The MasterSonic System should only be operated with manufacture approved transducers and cable.

ATTENTION! Do not connect the High Voltage (pin. 17) to grounding. This will damage the System.

2 Wire Connections:

If the acoustic load can only be connected with a two-wire cable, identify the wire that is connected to the acoustic load's ground (Low Voltage - LV) and the one connected to the isolated terminal (High Voltage - HV). Connect the wire that is connected to the acoustic load's ground/mass/housing to terminal 16-LV and the isolated terminal wire to terminal 17-HV. Connect terminal 16-LV and terminal 15-EARTH together. This will ground the acoustic load internally.

Note: The manufacturer does not recommend this connection method and should only be used if a three wire connection is not possible. Two wire connections should only be made by a qualified electrical technician.

3 Wire Connections: (PREFERRED METHOD)

The preferred method for connecting MasterSonic generator power supplies to acoustic loads is with a three-wire cable, as shown on the following schematic.

2. SYSTEM SET-UP

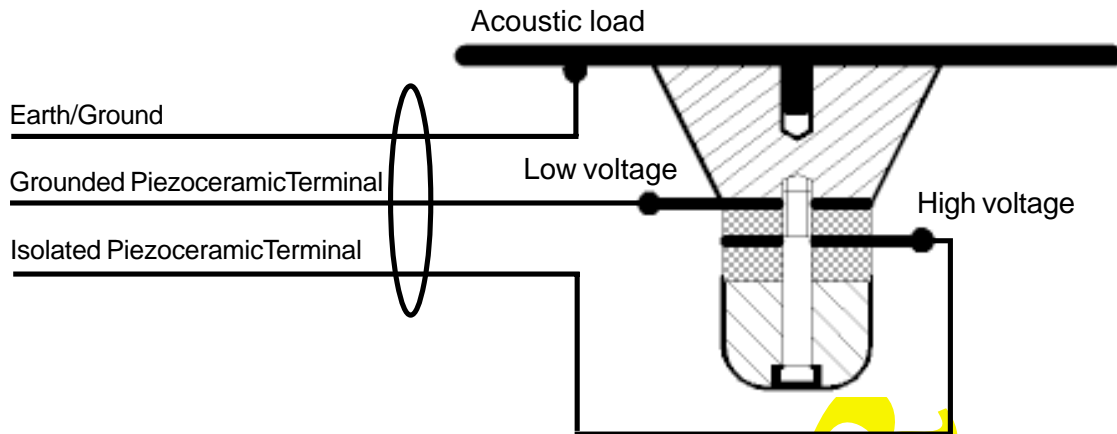

Fig. 2.1.2. Preferred 3-wire Acoustic Load connection.

- Isolated Terminal (terminals between ceramic disks or rings without contact to front or back mass of the converter) – This wire (normally Red / White / Black depending on supply source) is the HV (High Voltage) terminal of the ultrasonic transducer.
- Ground Terminal (terminals in contact with the front or back mass of the converter) – This wire (normally Green or Blue depending on supply source) is the LV (Low Voltage) terminal of the ultrasonic transducer.
- Earth/Ground/Mass (normally Yellow / Green / Blue) – This wire is connected to the metal part of the Acoustic Load.

Connect the acoustic load to the MSG.1200.OF as follows:

- Connect the Isolated Terminal (normally Red Black or White) wire to terminal 17 - HV.
- Connect the Ground Terminal (normally Green, Blue or Yellow) wire to terminal 16 - LV.
- Connect the Earth/Ground/Mass (normally Yellow/Green/Blue) wire to terminal 15 - EARTH.

CAUTION: Be careful when handling the acoustic load transducers or cable. The acoustic load may be charged with electro-static high voltage that may produce an electrical shock to the installer if not handled properly. Before installation or before connecting the acoustic load to the Mastersonic generator carefully touch the High Voltage Black wire to the Low Voltage Blue wire to short circuit and discharge electro-static build-up.

CAUTION: Do not place Generator on towel, foam or other soft surface that may block generator air vents. Blocking any vents may cause the Generator to overheat, malfunction, or create a shock hazard.

CAUTION: Connecting the Generator unit to mains which supplies improper voltage may cause the Generator to malfunction or create a shock or fire hazard.

CAUTION: The Generator should not be turned on until the Transducer Cable has been connected to both the Generator and Transducer. Otherwise, damage to the Generator may result.

CAUTION: The Generator Electrical Supply cord should not be plugged into a device (e.g. "power strips", "gang plugs", etc.) other than an industrial grade wall socket. Such other use could cause significant changes in voltage that could result in an electrical fault indication. This condition may occur even though other equipment plugged into multi-outlet sockets continues to operate.

2. SYSTEM SET-UP

2.1.3. Waveguide and Accessories Mounting:

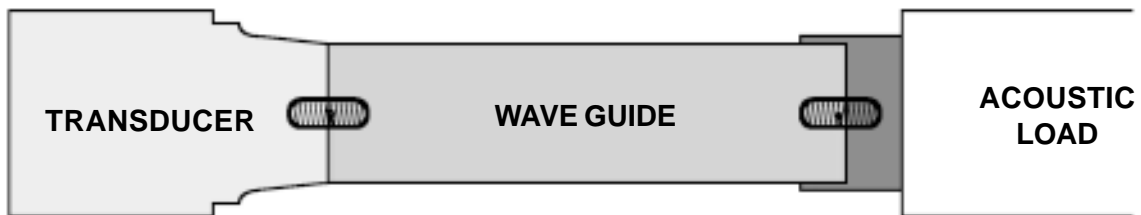

Figure 2.1.3. System Assembly

CAUTION: Ensure all connections and mating surfaces are clean and dry before assembly.

Use the supplied studs to interconnect the mechanical components. All components should be threaded by hand until snug, DO NOT force the threads, they must turn in smoothly all the way until the mating faces touch. Use two open end pin (spanner) wrenches and make final tightening.

As depicted in Figure 2.1.4. the Wave Guide or Booster should be connected to the transducer tip. Acoustic loads (probes, sonotrodes, etc.) are connected to the opposite end of the waveguide or Booster.

2.1.4. Flexible Transducer Option

The MSG.1200.OF systems offer a new and unique controllable inductive compensation option that enables driving of a large range of ultrasonic mechanical systems with any number of ultrasonic transducers. Acoustic load electrical parameters are the following:

- Average Operating frequency: 20kHz ÷ 40 kHz.
- Static capacity of the complex ultrasonic transducer: 3nF ÷ 100nF.



Fig. 2.1.4. Mastersonic Transducers

2. SYSTEM SET-UP

2.1.5. Inductive compensation.

THE ULTRASONIC MODULAR GENERATORS MSG 1200.OF ARE DESIGNED TO SUPPLY POWER LOADS UP TO 1200W IN THE FREQUENCY RANGE OF 19KHZ ÷ 45KHZ.

Reduce the generator power to 50% or less when adjusting the inductivity and operating frequency first time, in order to avoid any over-load situation.

THE RESONANT FREQUENCY IS SELECTED DURING PARAMETER SETTING WITH THE REMOTE CONTROL PANEL (CHAPTER 4.) THE INDUCTIVITY SHOULD THEN BE SET WITH A HEXAGON WRENCH KEY INSERTED INTO THE TOP OF THE MSG 1200.OF WHERE IT IS LABELED (L). INDUCTIVITY IS CHANGED AS THE FERRITE CORE IS OPENED OR CLOSED (core opening decreases the inductivity and vice versa).

THE INDUCTIVE COMPENSATION DEPENDS ON THE SYSTEM CENTER FREQUENCY, THE STATIC (shunt) CAPACITY OF TRANSDUCERS AND THEIR OPERATING MODE.

The inductivity of compensating coil can be measured by an inductivity meter, placed between the LV terminal and a control feather to its right, as shown in Figure 2.1.5. below (when the generator is not connected to a main power supply: fully OFF). If we know the desired central operating frequency of the transducer and its static capacitance, compensating inductance can be calculated and set in advance.



Fig. 2.1.5. Compensating Inductivity measuring

2. SYSTEM SET-UP

2.2. Factory Settings and Initial Generator Start Up.

The MasterSonic MSG.1200.OF generator includes an optional external power on safety circuit control that may be implemented through relay control of terminals 1 and 2. These terminals may be connected to a temperature control circuit, door panel switches, operator proximity safety switches, etc. To operate the generator module these terminals must be normally closed. An open circuit will stop all generator operations. If the installation does not require such external control these terminals 1 and 2 should be short circuited with a hard wire connection.

The MSG.1200.OF is delivered from the factory with a short circuit wire between terminals 1 and 2 to allow immediate operation.

For initial start up and testing safety the MSG.1200.OF is also delivered from the factory with a 330 Ohm resistor connected between terminals 5 and 6 to limit the generator power output to 30%. Upon initial connection of the generator to the acoustic load start the generator with this resistor in place to check operation in a low power mode. If the system operates properly turn the generator off, disconnect the mains power supply, and remove this resistor from terminals 5 and 6. After removal of this resistor the MSG.1200.OF power output may be controlled from 0% to 100% via the Remote Control Panel as described in section 4 below or by Analog Input Power Control as described in section 2.3.2. below.

2.2.1. Simplified methods for adjustment of MSG.1200.OF

Remote Control Panel Settings: (see section 4 below for Remote Control Panel connection and operation instructions)

1. Set the “**FREQUENCY**” equal to the nominal frequency of the ultrasonic transducer (equal to central operating frequency of the generator).
2. Set “**FAST SWEEPING**” to 32 (Dynamic MMM Sweeping).
3. Set “**SWEEPING**” to 2 (forced sweeping range).
4. Set “**POWER**” to 40%.
5. Set “**PWM PERIOD**” to 0.010s.
6. Set “**PWM RATIO**” to 100%
7. Set “**TRACKING RANGE**” to 30.
8. Calculate compensating inductance:

Compensating Inductivity Setting Sequence:

1. The “**COMPENSATING INDUCTIVITY**” initial value is determined by the following formula:

$$L = 1.05 \left(\frac{1}{4\pi^2 f^2 \cdot C} - L_s \right)$$

where:

L - inductivity of compensating coil in , H;

f - central operating frequency in Hz;

C - static (1 kHz) capacitance of ultrasonic transducer in , F;

L_s - Leakage Inductivity of the output transformer: approx. 300. 10⁻⁶ H

2. SYSTEM SET-UP

- 9. After the generator is started the output voltage and current should be checked. The load HF current should vary in the range between 1.1 and 4 A-rms.
- 10. The compensating inductivity should be readjusted using the Hex Key until the "TRACKING" starts fluctuating around zero.
- 11. When tracking is near zero the system should be ready for operation.

ATTENTION!

PLEASE, READ CAREFULLY THE WHOLE MANUAL BEFORE ADJUSTING THE MSG.1200.OF GENERATOR.

OBSERVE THE FOLLOWING REQUIREMENTS DURING PARAMETER SETTING:

| Table of Critical Settings | |
|---|---|
| "PWM-ratio" = 100% No limits regarding all other parameters. | "PWM-ratio" < 100% The following limits (below) should be respected. |
| "Tracking" = 0÷30 | "Tracking" = 0÷5 |
| "Sweeping" = 0÷7 | "Sweeping" < = 0÷4 |
| "Fast Sweeping" = 0÷255 | "Fast Sweeping" = 0÷40 |

2.3. Control Terminal Block.

The MSG.1200.OF control is performed through the Control Terminal Block, described below.

The control Terminal Block (fig. 2.3.) is placed on the upper side of the generator and implements the following functions:

- Terminals 1, 2, 3, 4, - Protection & Control; ON/OFF Power Control;
- Terminals 5 and 6 - Analogue setting of the power;
- Terminals 7, 8, 9, 10 - Remote Control Panel/PLC connection.

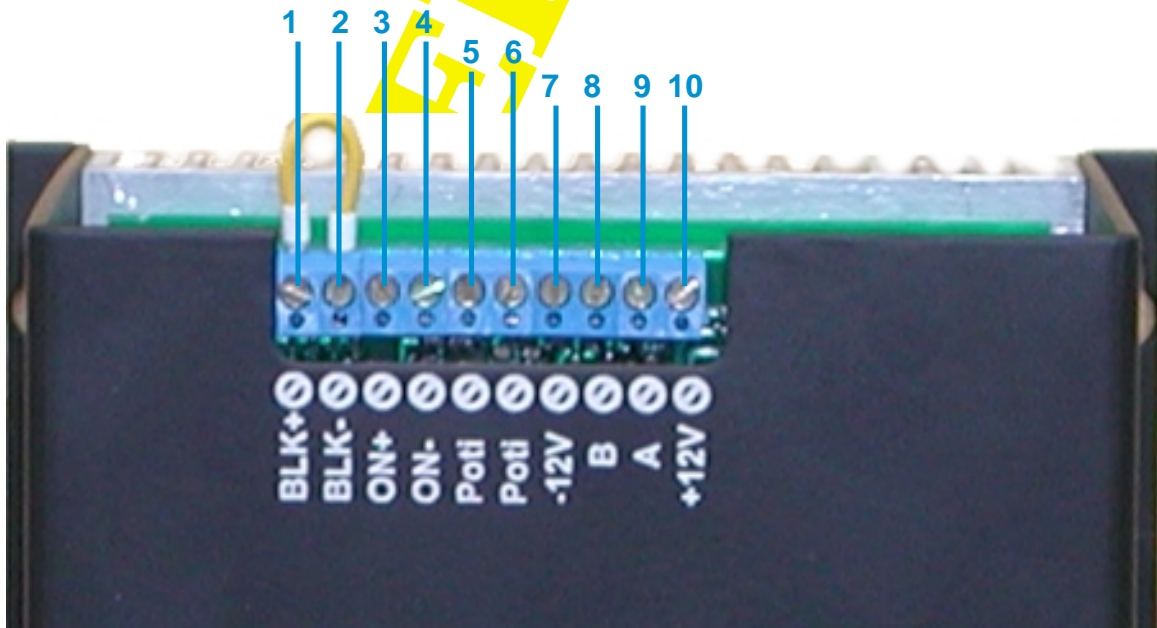

Fig. 2.3. Control Terminal Block

2. SYSTEM SET-UP

2.3.1. External On/Off Power Control:

External ON/OFF control of the generator is possible through connection of terminals 1, 2, 3, 4 as shown in figure 2.3.1. below. The generator is switched ON or OFF by relay or circuit control between terminals 3 and 4. When the terminals are closed the generator is switched on and when the terminals are open, the generator is switched off.

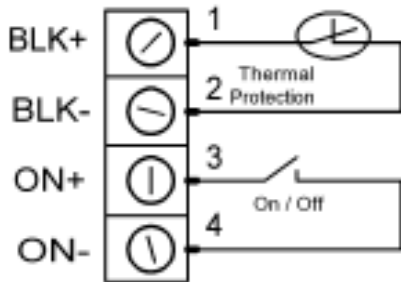

Fig. 2.3.1. External On/Off Power Control

NOTE: If the generator has been switched off because of activation of some internal blocking or external protection the terminals remain closed. Next starting of the machine should be done by opening and closing the terminals again.

NOTE: The thermo contact, controlling the temperature of the power transistors' heat-sink is connected to terminals on pins 1 and 2.

Do not break this circuit.

If you prefer to use additional external protection, connect the normal closed contacts in the thermal protection circuit.

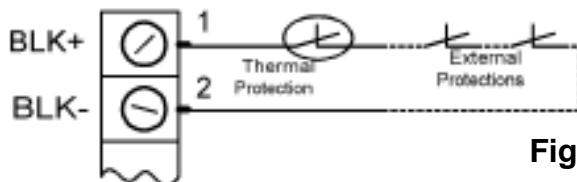

Fig. 2.3.1.a Thermal protection

2.3.2. Analog Input Power Control:

The power of the generator can be controlled in the following three ways:

- The power can be set during the parameter setting of the generator.
- The power can be set through the RS 485 serial interface by the changing power command of the Remote Control Panel or PLC.
- The power can be set through the analog input - terminals 5 and 6. When a 2.5 k-Ohm potentiometer is connected to terminals 5 and 6, as shown on picture 2.4., the power is set from 0 to 100%.

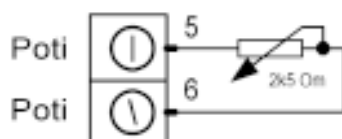

Fig. 2.3.2. Analog Input Power Control

2. SYSTEM SET-UP

2.3.3. Remote Control Connection:

The remote Control Panel or the MSA2218 Adapter for PC/PLC control is connected to terminals 7, 8, 9, 10 (see chapter 4.2.).

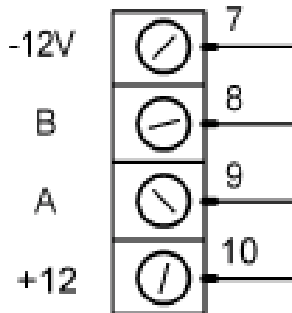

Fig. 2.3.3. Remote Control Connection

CAUTION: This connector is reserved exclusively for connecting MSA2218 Adapter of MasterSonic Remote Control Panel. Connecting other devices to these terminals or using the power supply for other purposes may damage your generator.

PRELIMINARY

2. SYSTEM SET-UP

2.4. Control Block

The Control Block of the generator is built on a separate PCB that also holds the control terminals and sweeping function control jumpers.

The generator's control is designed on several microprocessors and a Field programmable logic. These provide the intelligence necessary for the generation of sonic and ultrasonic frequencies, according to the assignment and the selection of feedbacks.

Through selection of various signal generation/control and feedback options to the system you can achieve extraordinary control of the acoustic system connected to the MSG.1200.OF generator.

Control Board Jumpers (J1 and J2 as shown on fig. 2.5.) allow you to choose between two modulation techniques applied to of the acoustic load's resonant frequency. By switching one or both types of modulation (called "Sweeping"= Forced Sweeping Mode and "Fast Sweeping"= Dynamic MMM Mode) you can obtain both traditional modulations and new dynamic signal modulation applied to the acoustic load.

Placing the two jumper blocks to the OFF position turns your MSG.1200 .OF generator into a conventional generator, operating on resonant frequency of the acoustic load. All other combinations are defined below.

2.5. Control Board Jumpers

Fig. 2.5. shows the position of Jumpers J1 and J2 on the control PCB.

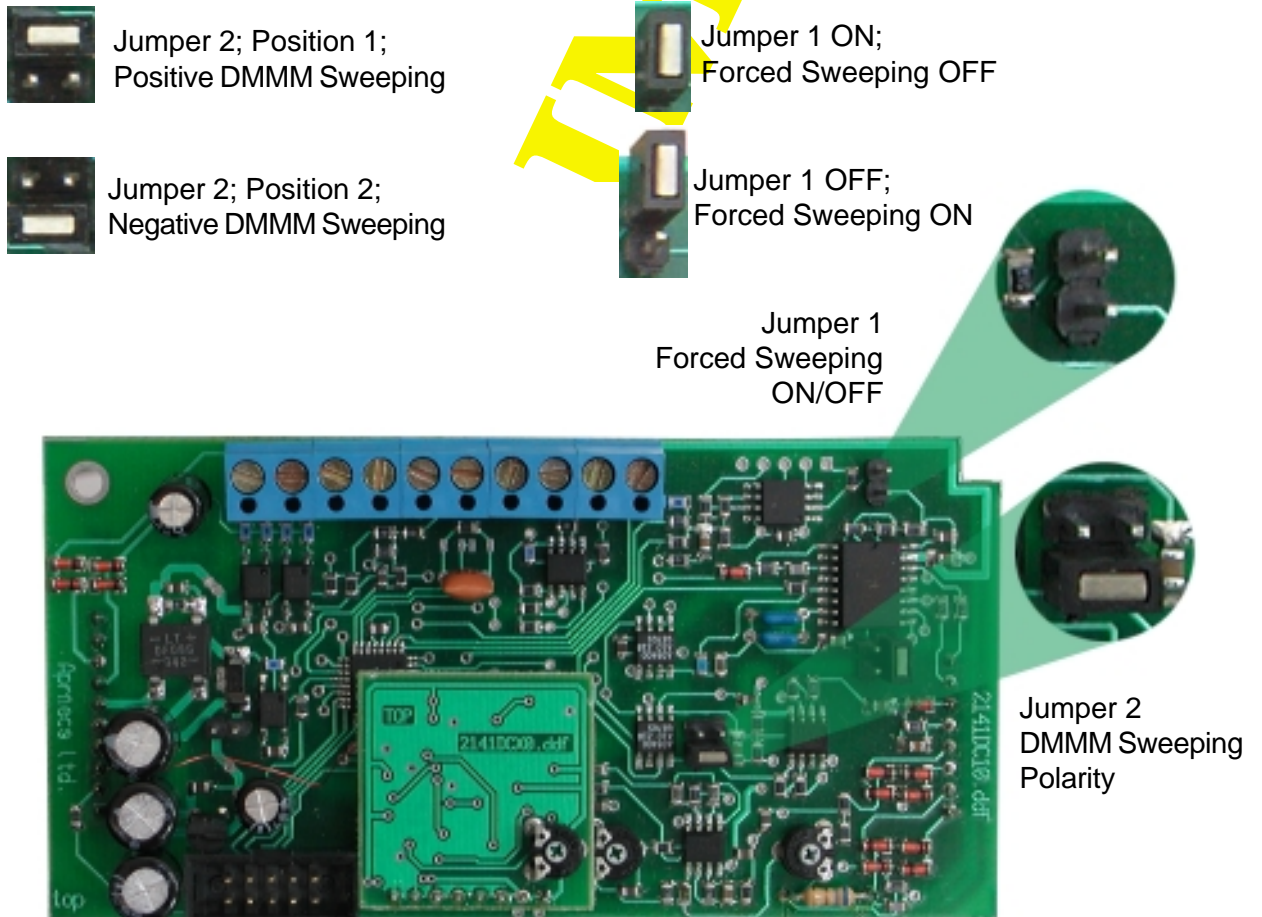

Fig 2.5. Control Board Jumpers

2. SYSTEM SET-UP

The selection of Forced Sweeping – modulation called “Sweeping” – generates forced MMM ultrasonic oscillations in the acoustic load. The algorithm implemented in the microprocessor, using the feedback from the Acoustic Load, calculates specifically modulated frequency output, which generates stable and forced MMM oscillations into the acoustic load.

The Dynamic MMM (DMMM) Sweeping modulation block (“Fast Sweeping”) will normally provide excellent results, because this is designed to excite an Acoustic Load of any size and shape in many of its resonant modes, at the same time. The optimally selected feedback from the acoustic load (specifically transformed with MMM signal processing block) will initiate real time Dynamic change of MMM oscillations by tracking the time-evolving load properties in a wide-band and multifrequency regime of oscillations. This will generate completely homogenous 3-Dimensional (3D) ultrasonic activity in an ultrasonic cleaner.

The optimal selection of feedback-parameters (Jumpers J1 and J2) is very important for generation of homogeneously distributed 3D ultrasonic activity field. The acoustic load’s feedback-phase (positive and negative leading edge of DMMM) will significantly effect the dynamic mode and is therefore also very important for the proper operation of DMMM Sweeping.

Consequently, the optimum method for obtaining homogenous 3D ultrasonic activity in mechanically different acoustic loads is the heuristic method where the systems integrator will determine the best settings by testing and discovering results themselves.

Fig.2.5. and Table 2.5. show the position of J1 and J2 and the adjustment of different operating modes of MSG.1200 .OF ultrasonic generator.

Table 2.5.

| T.1 | J 1 | J 2 | | Resulting Operating Regimes |
|-----|-----|---------|---------|---|
| | | J 2 - 1 | J 2 - 2 | |
| 1 | on | on | off | Forced Sweeping = OFF DMMM Sweeping = ON Activates Positive Leading Edge of the DMMM-Sweeping |
| 2 | on | off | on | Forced Sweeping = OFF DMMM Sweeping = ON Activates Negative Leading Edge of the DMMM-Sweeping |
| 3 | off | on | off | Forced Sweeping = ON Activates Positive Leading Edge of the DMMM-Sweeping with Math Sweeping |
| 4 | off | off | on | Forced Sweeping = ON DMMM Sweeping = ON Activates Negative Leading Edge of the DMMM-Sweeping with Math Sweeping |
| 5 | off | off | off | Forced Sweeping = ON DMMM Sweeping = OFF Only Math Sweeping is activated. |
| 6 | on | off | off | Forced Sweeping = OFF DMMM Sweeping = OFF The generator operates on Constant frequency. |

NOTE: All other jumpers & potentiometers are factory selected (not to be changed by end user).

2. SYSTEM SET-UP

2.6. Sweeping Adjustment.

The MSG 1200.OF are designed for complex purposes and complex loads.

It is not recommended that MSG1200.OF are used in constant resonant frequency operating, such as plastic-welding applications. For that purpose the manufacturer offers the MSGXXX.OW ultrasonic generator type that is especially designed for operating plastic welding and similar type transducers.

The MSG1200.OF is designed to operate in DMMM Frequency regimes, as well as in Constant Frequency regimes. The table below describes all operating modes:

Table 2.6.

| T.1 | J 1 | J 2 | | Resulting Operating Regimes |
|-----|-----|---------|---------|---|
| | | J 2 - 1 | J 2 - 2 | |
| 1 | on | on | off | Math-Sweeping = OFF DMMM-Sweeping = ON Activates Positive Leading Edge of the DMMM-Sweeping; Significant Handy keyboard settings are: "Sweeping" = 0 "Fast Sweeping" = 30÷180 (the best is 100) "Tracking Range" = 5÷20 (the best is 15) |
| 2 | on | off | on | Math-Sweeping = OFF DMMM-Sweeping = ON Activates Negative Leading Edge of the DMMM-Sweeping; Significant Handy keyboard settings are: "Sweeping" = 0 "Fast Sweeping" = 30÷180 (the best is 100) "Tracking Range" = 5÷20 (the best is 15) |
| 3 | off | on | off | Math-Sweeping = ON Activates Positive Leading Edge of the DMMM-Sweeping with Math Sweeping; Settings: "Sweeping" = 2÷6 (the best is 2) "Fast Sweeping" = 30÷180 (the best is 100) "Tracking Range" = 5÷20 (the best is 15) |
| 4 | off | off | on | Math-Sweeping = ON DMMM-Sweeping = ON Activates Negative Leading Edge of the DMMM-Sweeping with Math Sweeping; Settings: "Sweeping" = 2÷6 (the best is 2) "Fast Sweeping" = 30÷180 (the best is 100) "Tracking Range" = 5÷20 (the best is 15) |
| 5 | off | off | off | Math-Sweeping = ON DMMM-Sweeping = OFF Only Math Sweeping is activated; Significant Handy keyboard settings are: "Sweeping" = 2÷6 (the best is 2) "Fast Sweeping" = 0 "Tracking Range" = 5÷20 (the best is 10) |
| 6 | on | off | off | Math-Sweeping = OFF DMMM-Sweeping = OFF Constant frequency operation = ON Significant Handy keyboard settings are: "Sweeping" = 0 "Fast Sweeping" = 0 "Tracking Range" = 0 |

2. SYSTEM SET-UP

● **Activating Only Dynamic MMM- Sweeping (without Math Sweeping): T.1 (1 + 2)**

Jumper J1 = ON (closed contacts) = Math Sweeping is deactivated,
 Jumper J2 = position 1 = Activates Positive Leading Edge of the DMMM-Sweeping
 Jumper J2 = position 2 = Activates Negative Leading Edge of the DMMM-Sweeping

Use the handheld control panel or PC control to set the following parameters:

Sweeping = 0; Fast Sweeping = 30 to 150 (best between 60 and 80); Power = 0 to 100%; PWM Period = 0.010s to 0.2s (best between 0.01s to 0.1s); PWM Ratio = 50% to 90% (best from 85% to 90%); Frequency = 19.020 to 46.728 kHz; Tracking Range = 5 to 20 (best 7 to 15)

● **Activating Mixed Dynamic MMM- Sweeping and Math-Sweeping: T.1 (3 + 4)**

Jumper J1 = OFF (open contacts) = Math Sweeping is activated,
 Jumper J2 = position 1 = Activates Positive Leading Edge of the Dynamic MMM-Sweeping
 Jumper J2 = position 2 = Activates Negative Leading Edge of the MMM-Sweeping 2

Use the handheld control panel or PC control to set the following parameters:

Sweeping = 1 to 5 (best between 2 and 4); Fast Sweeping = 30 to 150 (best between 60 and 80); Power = 0 to 100% (best between 85% and 90%); PWM Period = 0.010s to 0.1s; PWM Ratio = 50% to 100% (best at 100%); Frequency = 19.020 to 46.728 kHz; Tracking Range = 5 to 30 (best at 15)

● **Activating Only Math-Sweeping (without Dynamic MMM-Sweeping): T.1 (5)**

Jumper J1 = OFF (open contacts) = Math Sweeping is activated,
 Jumper J2 = OFF, (OPEN)
 Jumper J2 = OFF, (OPEN)

Use the handheld control panel or PC control to set the following parameters:

Sweeping = 1 to 5 (best between 2 and 4); Fast Sweeping = 0; Power = 0 to 100%; PWM Period = 0.010s to 0.2s (best between 0.01s and 0.1s); PWM Ratio = 50% to 100% (best from 85% to 100%); Frequency = 19.020 to 46.728 kHz; Tracking Range = 5÷20 (best 7 to 15)

● **Activating Fixed Frequency Operating Regime: T.1 (6)**

Jumper J1 = ON (closed contacts) = Dynamic MMM-Sweeping is deactivated,
 Jumper J2 = position 1 = OPEN,
 Jumper J2 = position 2 = OPEN

Use the handheld control panel or PC control to set the following parameters:

Sweeping = 0
 Fast Sweeping = 0
 Power: from 0 to 100%
 PWM Period = 0.010s
 PWM Ratio = 100%
 Frequency: from 19.020 to 46.728 kHz
 Tracking Range = 0

2. SYSTEM SET-UP

2.7. MSG.1200.OF Generator Parameters:

Programming and parameter adjustments to the MSG.1200OF is done through the MasterSonic Remote Control Panel MSH-1 or the MSA2218 Adapter for PC/PLC control in combination with the MasterSonic PC software program.

The following generator parameters can be set and adjusted:

Table 2.7.

| Parameter | Description | Parameter Range |
|----------------------------|---|-----------------------|
| Frequency | Central Operating Frequency of the ultrasonic generator | 19.020kHz ÷ 46.728kHz |
| Fast Sweeping (=DMMM) | The amplification coefficient in the Fast Sweeping range of the Central Operating Frequency | 0 ÷ 255 steps |
| Sweeping (= Math Sweeping) | The amplification coefficient proportional to the Sweeping range of the Central Operating Frequency | 0 ÷ 7 steps |
| Power | The power of the generator as a percent of the nominal power. | 0 ÷ 100 % |
| PWM Period | PWM Period duration at operation in ON/OFF mode of the generator. | 0.010s ÷ 1.000s |
| PWM Ratio | The ON period as a percent of the PWM Period. | 0 ÷ 100 % |
| Tracking Range | Max. acceptable correction of the Central Operating Frequency as an absolute value, computed by the in-built DPLL system. | 0 ÷ 30 steps |

The operation with the Remote Control Panel or the MasterSonic software through the MSA2218 Adapter is described in the following chapters.

2.7.1. Important notices regarding using PWM timing options.

- In most of applications for driving different piezoelectric loads it is not necessary or recommendable to use PWM options (just set PWM Ratio = 100%).
- The safest choices when using PWM options is necessary or beneficial for application are to set PWM Ratio in the range between 85% and 95%, and PWM Period from 0.01sec to 1sec (for instance in cleaning applications, liquids processing, Sonochemistry).
- PWM signal modulation presents Low frequency output power, ON OFF modulation. Such modulation is basically producing high electrical and mechanical shocking (on both generator and transducer), equal to a kind of pulse repetitive hammering effects, and if not well selected could shorten the total operating life of the ultrasonic system.

3. FRONT PANEL

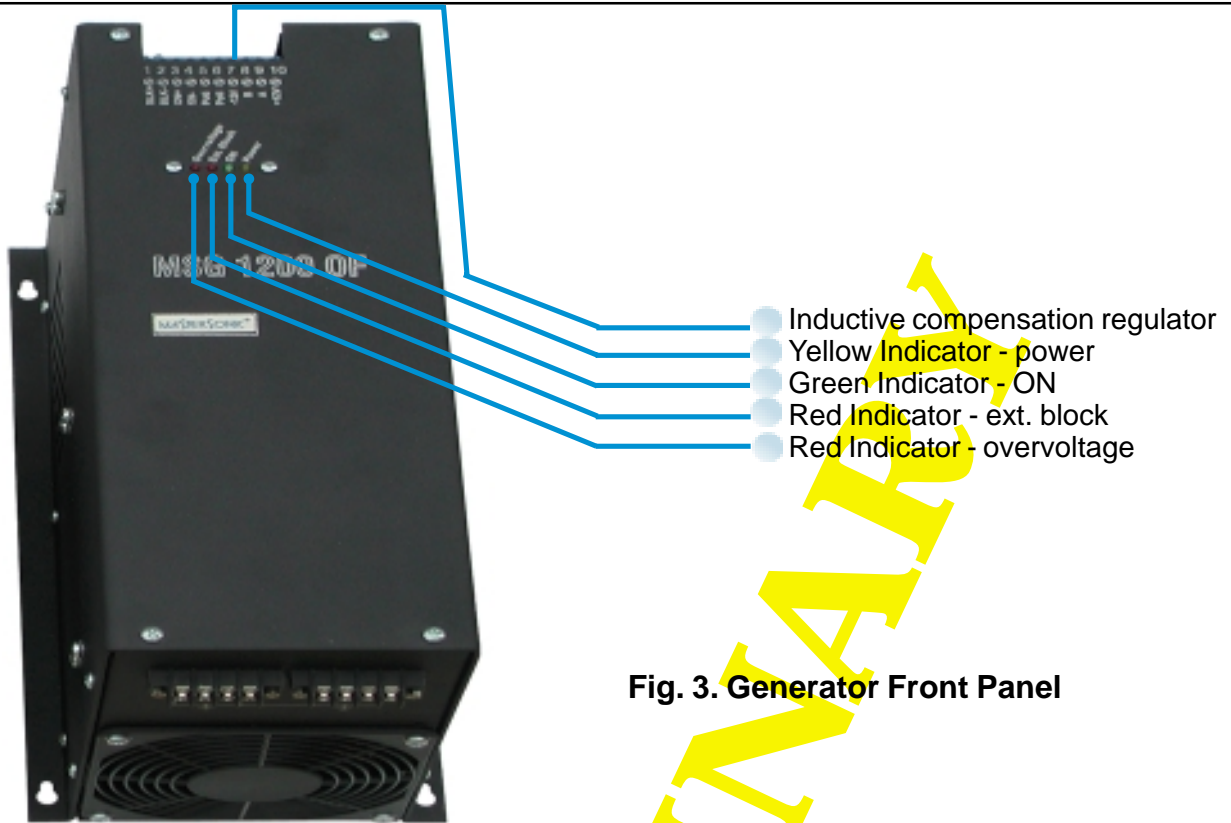

Fig. 3. Generator Front Panel

3.1. Yellow Indicator light:

The yellow indicator light is illuminated (ON) when the generator is connected to the mains power.

3.2. Green Indicator light:

The green light is illuminated (ON) when the generator is turned ON and producing ultrasonic power output to the transducer. When the generator output power is turned OFF this light is not illuminated.

3.3. Red ext. block Indicator light:

The right red indicator is connected to the generator protection circuits. If the generator is experiencing an external problem or detecting a problem with the mechanical ultrasonic components it will automatically stop ultrasonic power generation. Then the red light is illuminated. The light will turn off at next start up of the generator.

3.4. Red overvoltage Indicator light:

The left red indicator light is on when the overvoltage protection is actuated. The light will turn off at next start up of the generator.

3.5. Inductive compensation regulator.

The inductive compensation regulator controls the inductivity by regulating the airgap of the ferrite core.

Turning the regulator to “-” opens the airgap of the ferrite core and the inductivity decreases.

Turning the regulator to “+” closes the airgap of the ferrite core and the inductivity increases.

- When the ferrite core is closed the inductivity is approx. 2mH
- When the Ferrite core is max. opened the inductivity is approx. 1mH.

ATTENTION: The inductivity is set to max. during transportation.

4. REMOTE CONTROL PANEL

4.1. Remote Control Panel Description:

The remote control panel is designed for rapid parameter setting and tuning of the ultrasonic generator while connected to the oscillating mechanical system.

4.2. Remote Control Panel Connection:









Connection of the remote control panel to the generator is made by a special cable, which is connected to terminals 7, 8, 9 and 10. The remote control connection should be made as shown on figure 2.3, page 13:

| Terminal No | Cable Colour | Signal Name | Handy pin # |
|-------------|--------------|-------------|-------------|
| 7 | Blue | -12V | 5 |
| 8 | White | B | 2 |
| 9 | Black | A | 6 |
| 10 | Brown | +12V | 4 |

4.3. Remote Control Panel Operation:

The remote control panel has an LCD display with 2 rows of 16 symbols and keyboard with 24 buttons that have the following functions:

Numeric keyboard from 0 to 9 and decimal point for entering new parameters.

-  **Enter** button to input parameters or initiate a Function.
-  **“esc”** button to escape or cancel current operation.
-  **Up** and **Down Arrow** buttons for increasing and decreasing display values.
-  **Left** and **Right Arrow** buttons for reading the LCD menu.
-  **Power On** Button - switches the Power Supply of the Remote Control Panel.
-  **Alt** Button for extending the functions of the Remote Control Panel (intended for future applications).
-  **Run** Button Starts the generator.
-  **Off** Button Stops the generator.

Functions buttons:



-  **F1** - reads parameter data stored in the controller memory. Press F1 then select a memory position (0 to 20) to view stored parameters.
-  **F2** - stores new parameter data from the buffer to a selected memory position (0 to 20) in the controller.
-  **F3** - downloads parameter data from the buffer to the MasterSonic generator memory.



Fig. 4. Remote Control Panel

4. REMOTE CONTROL PANEL

NOTE: If the Mastersonic generator is in operation (ultrasonic power is ON) when downloading data from the remote control panel the generator will automatically turn OFF the ultrasonic power for system safety. The generator may be restarted manually by switching the ON/OFF switch, connected to terminals 1 and 2, or by pressing the RUN button of the Remote Control Panel.

4.3.1. When the remote control panel is connected to the MasterSonic generator, the active set of generator parameters that are in its memory are automatically transferred to the buffer of the control panel.

4.3.2. To set Operating Frequency – select desired parameter with LEFT and RIGHT ARROW buttons. Select parameter value with UP and DOWN ARROW buttons, or with numeric keyboard. The ENTER button downloads the current parameter value in the generator.

4.3.3. To set Ultrasonic Output Power – select desired parameter with LEFT and RIGHT ARROW buttons. Select parameter value with UP and DOWN ARROW buttons, or with numeric keyboard. The ENTER button downloads the current parameter value in the generator.

4.3.4. To set PWM Period– select desired parameter with LEFT and RIGHT ARROW buttons. Select parameter value with UP and DOWN ARROW buttons, or with numeric keyboard. The ENTER button downloads the current parameter value in the generator.

4.3.5. To set PWM Ratio– select desired parameter with LEFT and RIGHT ARROW buttons. Select parameter value with UP and DOWN ARROW buttons, or with numeric keyboard. The ENTER button downloads the current parameter value in the generator.

4.3.6. To set Fast Sweeping select desired parameter with LEFT and RIGHT ARROW buttons. Select parameter value with UP and DOWN ARROW buttons, or with numeric keyboard. The ENTER button downloads the current parameter value in the generator.

4.3.7. To set Sweeping select desired parameter with LEFT and RIGHT ARROW buttons. Select parameter value with UP and DOWN ARROW buttons, or with numeric keyboard. The ENTER button downloads the current parameter value in the generator.

4.3.8. To set Tracking range select desired parameter with LEFT and RIGHT ARROW buttons. Select parameter value with UP and DOWN ARROW buttons, or with numeric keyboard. The ENTER button downloads the current parameter value in the generator.

4. REMOTE CONTROL PANEL

Table 4.

| Function | LCD Display Pictures | LCD Displays | Description of Action |
|--------------------|----------------------|--|--|
| Reading Data | | <<<< CRxxx (xxx = generator version) | Uploading parameters from the generator memory to the remote control panel buffer. |
| Sending Data | | >>>>>> | Downloading parameters from the remote control panel buffer to the generator memory. |
| Read Memory | | Location xx | Reading parameters from a remote control panel memory location (1 to 20) to the remote control panel buffer. |
| Write Memory | | Location xx | Writing parameters from the remote control panel buffer to the remote control panel memory location (1 to 20). |
| Frequency | | xx.xxx kHz (example: 21.940 kHz) | The average frequency of the ultrasonic transducers (resonant mode). |
| Fast Sweeping | | xx stp (example: 25 stp) | Fast Sweeping (0-255 steps) |
| Sweeping | | x (example: 3) | Sweeping (0-7) |
| Information Screen | | Ihf = Current Tr = Tracking Iac = input AC | Only information screen. |
| Power | | xxx %(example: 50%) | The current power as a percent of nominal power of ultrasonic generator. |
| PWM Period | | x.xxxx (example: 1.190 s) | Period of Pulse Width Modulation (PWM in seconds). |
| PWM Ratio | | xx% (example: 65%) | Ratio of Pulse Width Modulation (PWM percent) |
| Tracking Range | | xx (example: 25) | Tracking Range of DLL tracking (auto tune range from 0-30) |

5. PC SOFTWARE CONTROL OPTION

5.1. PC and Custom Software Control Description:

MasterSonic generator parameters may be automatically controlled through a PC or other custom controller connected to the RS485 serial interface via the optional adaptor box.

NOTE: Only one device may be connected to the RS 485 serial interface. The optional PC control adapter box and the remote control panel may not be used at the same time.

5.2. PC Graphical User Interface Window:

The optional PC software control accessory is used to control generator parameters through a PC connected via the special interface adaptor box to the MasterSonic RS485 serial interface.

5.2.1. Installation Instructions for the MasterSonic Control Panel Window: (Windows 98 compatible)

a) Create a new file folder on your PC in a location where you prefer to store the executable software files.

b) Copy the file “mastersonic.exe” from the MasterSonic CD and paste in your new file folder.

c) Right click the copied file “mastersonic.exe” and left click the “make a shortcut” option. Drag the shortcut to your PC desktop or another convenient location.

5.2.2. To run the MasterSonic PC Control Panel Window:

a) Double click the “mastersonic.exe” shortcut icon.

b) The MasterSonic Generator Control Panel window will appear. If the PC serial port is properly connected to the MasterSonic Generator the active set of generator parameters that are in its memory are automatically uploaded and displayed in the Control Panel window.

5.2.3. To READ Currently loaded Parameters in the MasterSonic Generator memory:

a) Click the PC control panel “Read” button.

b) Parameters are uploaded from the MasterSonic generator memory and displayed on the PC Control Panel window.

5.2.4. To Set New Parameters and WRITE them to the MasterSonic Generator:



Figure 5. PC Windows Control Panel

5. PC SOFTWARE CONTROL OPTION

- a) Each parameter may be set by either the sliding graphic bar or by typing specific numerical values. (Parameter setting limitations are as described for the control panel above.)
- b) When all parameters are set to the desired value Click the PC control panel “Write” button.
- c) All parameters will be downloaded from the PC Control software to the MasterSonic generator.

NOTE: If the Mastersonic generator is in operation (ultrasonic power is ON) when downloading data from the PC control panel the generator will automatically turn OFF the ultrasonic power for system safety. After downloading is completed the generator may be restarted manually by pressing the front panel Green ON button or via the control panel start button.

5.2.5. Start or Stop the MasterSonic Generator:

- a) After desired parameters have been set Click the “START” button.
- b) Press the “STOP” button to stop ultrasonic power generation.

5.2.6. To Quit or Exit from the PC Control Window:

- Click the “EXIT” button.

5.3. Custom Controller or Special PC Command Options:

Using MasterSonic MSA2218 Adapter RS485 / RS232C interface, users may develop or use industry standard controllers and PCs for programming and controlling the MasterSonic generator via the optional interface adaptor box.

NOTE: Only one device may be connected to the MSG RS485 serial interface - terminals 7, 8, 9 and 10. A Custom Controller and the remote control panel may not be used at the same time.

NOTE: This option is not a part of the standard support. Assistance for hardware interface and programming are quoted by the manufacturer or distributor on a case by case basis.

5.3.1. The RS232C transfer protocol is semi-duplex and data transfer (reading/writing) and is controlled by RTS signaling.



5. PC SOFTWARE CONTROL OPTION

5.3.2. MasterSonic Generator Commands.

NOTE: Each command is terminated with carriage return (CR) ASCII code HEX ="0D " or decimal = 13

| Inquiry Commands: | |
|-------------------|--|
| %04f(CR) | inquire for Current Frequency of the generator |
| %04s(CR) | inquire for Current Fast Sweeping of the generator |
| %04d(CR) | inquire for Current Sweeping of the generator |
| %04w(CR) | inquire for Current PWM Period of the generator |
| %04m(CR) | inquire for Current PWM coefficient of the generator |
| %04t(CR) | inquire for Current potentiometer value |
| %04c(CR) | inquire for Current Electricity value of the generator |
| %04p(CR) | inquire for Current Power of the generator |
| %04SR(CR) | inquire for Firmware Version |
| %04?(CR) | inquire for Phase, Current and Tracking information |

| Inquiry Reply Formats: | |
|------------------------|---|
| #02fxxx(CR) | Current Frequency reply. (xxx is frequency in kHz) o (0-255kHz) |
| #02sxxx(CR) | Current Fast Sweeping reply. o (0-255stp) |
| #02dxxx(CR) | Current Sweeping reply. o (0-7) |
| #02wxxx(CR) | Current PWM Period reply. o (1-100) - (10ms-1000ms) |
| #02mxxx(CR) | Current PWM coefficient reply. o (0 - 100%) |
| #02txxx(CR) | Current position of power potentiometer. o (0-100%) |
| #02cxxx(CR) | Current Electricity value reply. o (0-400) (0-4A) |
| #02pxxx(CR) | Current Power reply. o (0-100%) |
| #02SR002(CR) | Firmware Version Reply |
| #02?xxxxyyzzzααα(CR) | xxx - Phase (0-999 relative units) yyy - Current (0-500) (0-5A) zzz - Tracking (0-60 relative units) ααα - AC current (0-5A) |

5. PC SOFTWARE CONTROL OPTION

| Start/Stop Generator Ultrasonic Power Commands: | |
|---|---------------|
| @04start(CR) | Start command |
| @04stop(CR) | Stop command |
| @04wr(CR) | Write command |

| Set New Parameter Value Commands: | |
|-----------------------------------|--|
| #04fxxx(CR) | Sets a new Operating Frequency for the generator (0-255) |
| #04sxxx(CR) | Sets a new Fast Sweeping Frequency (0-255) |
| #04dxxx(CR) | Sets a new Sweeping Frequency (0-7) |
| #04wxxx(CR) | Sets a new PWM Period 1-100 (10-1000ms) |
| #04mxxx(CR) | Sets a new PWM Coefficient (0-100%) |
| #04pxxx(CR) | Sets new Power (0-100%) |

NOTE: The generator replies with a character ">(CR)" after receiving the setting parameters. The reply is not controlled.

Data transfer: According to RS232 / RS485 Protocol.

Note: The manufacturer recommends that only original MasterSonic MSA2218 Adapter is used with the MasterSonic generator.

Comments:

MODE: Asynchronous
 DATA: 8 data bits
 Stop: 1
 Baud rate: 19200
 Parity: No
 Txd - 1 = Send
 Rxd - 0 = Receive

6. LIMITATION OF WARRANTY

The product warranty is detailed in the general conditions of sale or as part of a special sale agreement.

The warranty does not apply and may be voided for equipment subject to unauthorized modifications, repair, misuse, abuse, negligence or accident.

Equipment that, in our judgment, shows evidence of having been used in violation of operating instructions will be ineligible for service under this warranty.

The MasterSonic equipment is designed for maximum operator safety and incorporates built-in safety devices. Any modifications to these safety features will void the warranty. The Manufacturer assumes no responsibilities for consequential damages incurred due to modifications to the said equipment.

Under no circumstances shall the Manufacturer be liable to the purchaser or to any other person for any incidental or consequential damages or loss of profit or product resulting from any malfunction or failure of this MasterSonic product.

No liability is assumed for expenses or damages resulting from interruptions in operation of the product or damages to material in process.

The Manufacturer reserves the rights not to warrant horns, sonotrodes, and waveguides of unusual or experimental design that in our judgment are more likely to fail in use.

Within the period guaranteed, we will repair or replace free of charge, at our sole discretion, all parts that are defective because of material or workmanship, not including costs for removing or installing parts.

Liability, whether based on warranty, negligence or other cause, arising out of and/or incidental to sale, use or operation of the transducer elements, or any part thereof, shall not in any case exceed the cost of repair or replacement of the defective equipment, and such repair or replacement shall be the exclusive remedy of the purchaser, and in no case will we be responsible for any and/or all consequential or incidental damages including without limitation, and/or all consequential damages arising out of commercial losses.

7. SERVICE

WARNING: To avoid electric shock, do not remove the case cover from the Generator or Transducer. There are no user-serviceable parts inside any of these components.

IMPORTANT NOTICE: For the protection of employees, shippers, receivers, various personnel, and to remain in compliance with Transit Laws, material returned to the Manufacturer or its designated representatives must be rendered free of any hazardous, noxious or radioactive contamination.

Should the user of this device have any questions or comments as to its specifications, use, limitations, or maintenance, the Manufacturers Service Representative can be contacted as follows:

By Post/Mail: MP Interconsulting
Attn: MasterSonic Service
Marais 36
2400 Le Locle, Switzerland

Telephone/Fax: +41 32 9314045
E-mail: mastersonic@mpi-ultrasonics.com;
www.mpi-ultrasonics.com

PRELIMINARY

OUTLINE DIMENSIONS OF MSG 1200.OF

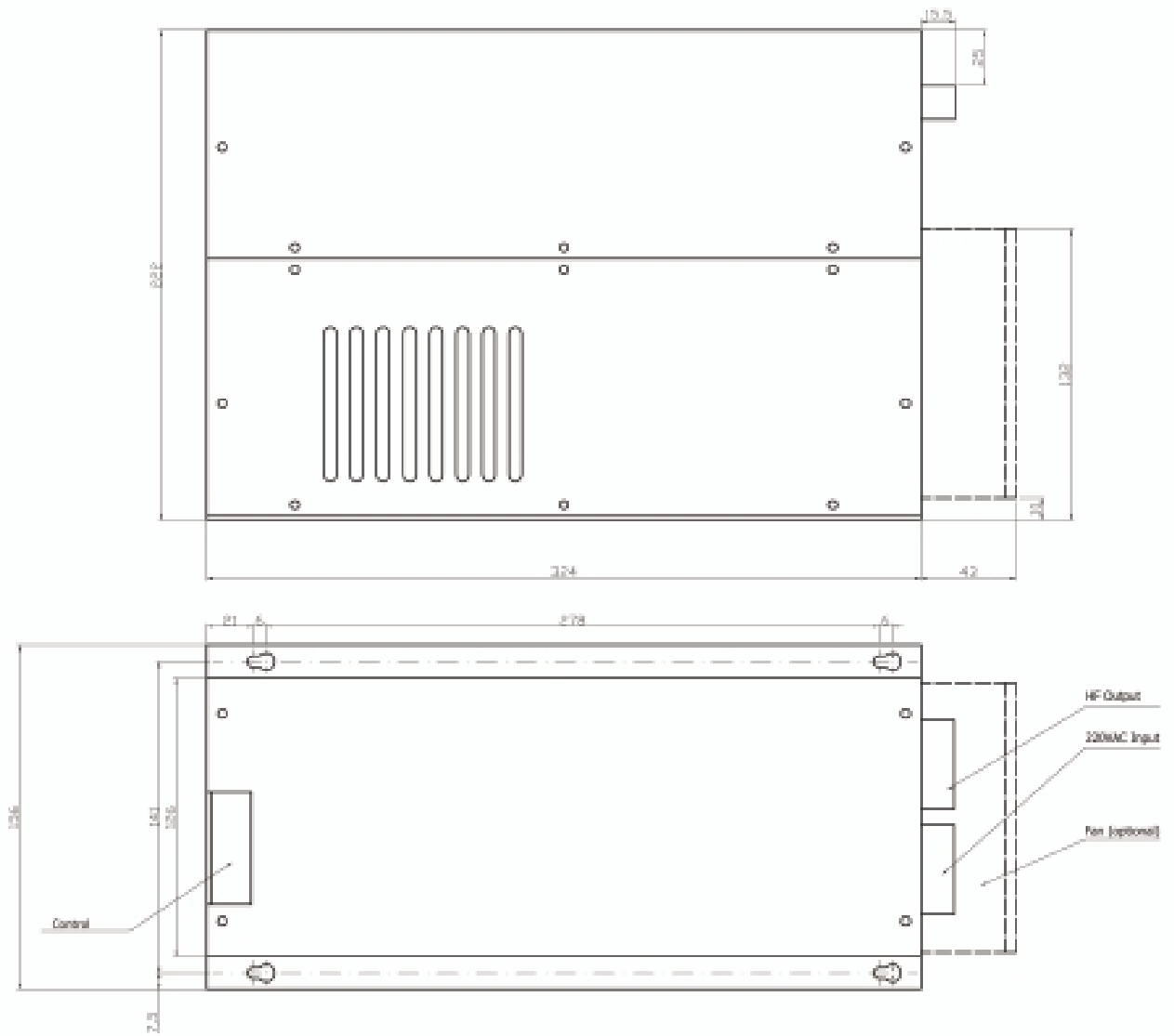

PRI