

General Classification of SONOREACTORS

We have a number of options to address **flow-through Sonochemistry**. As you can see there are many elements we can use in our chamber designs. We can offer complete systems built for your needs or for clients with the capability to construct the chamber parts we may also consider selling just the ultrasonic components.

In addition to some standard components you will find that we are offering some very unique technology. For example if you decide on the very high surface power density probe solution please note that ours is the highest power system available. None of the leading industry brands are offering the same level of power output to the liquid. This is very important for some Sonochemical testing where you need to test low power as well as very high power.

Our Pipe-Clamp solution is a technology that will only function with our MMM generators. We can design clamps to fit nearly any size pipe and drive 1 to 5 converters and clamp assemblies from one generator.

SONOREACTORS Group A: HVPD

- High volumetric (typically 5 to 50 W/dm³) and low surface power density (typically 0.5 to 2 W/cm²)
- Large radiating surface/s (transducer arrays)
- Moderate or high volume-power-density: HVPD
- Multifrequency and single frequency systems

SONOREACTORS Group B: HSPD

- High surface-power-density of ultrasonic radiation: HSPD
Typically 100 W/cm² or higher (until 500 W/cm²)
- Small radiating surface (and very high intensity of radiation)
- Single frequency systems
- Single-Probe Systems

We need to learn more about your application to give better advice on the equipment that will best meet your needs. Please tell us: What kind of liquid material you wish to treat? Do you prefer to use the effects of even cavitation or a combination high acoustic power plus cavitation to break particles? Will you need to treat a large volume or small volume? Is your need for batch treatment or continuous flow?

Please visit our website for more details and have a look at our production line technology, or contact us directly with any inquiries.

Homepage: <http://www.mpi-ultrasonics.com>

E-mail: mpi@mpi-ultrasonics.com

mpi@mastersonic.com, mpi@bluewin.ch

Group A): High volumetric and low surface power density ultrasonic treatment: HVPD

Applications: Ultrasonic cleaning in a liquid bath or special reactor cleaning applications, Sonochemistry, Electrochemistry, Surface treatment, Extractions, Nano technologies, Water treatment, Petrochemicals Cracking, Liquid food treatment, Degassing, Defrosting, Impregnation

System solutions may be grouped as follows:

Ultrasonic Baths (1): Such systems are used when it is important to deliver uniform and homogenous ultrasonic energy over a large surface as found in standard bath systems. Using transducer elements with a large radiating surface the power density is usually on the order of 0.5 to 2 Watts per square centimeter. Such power is providing very good cavitation effects and uniform power distribution throughout the liquid bath or special cleaning chamber.

Through the use of **Submersible Box Transducers (2)**, **Plate Mount Transducers (3)**, Tubular Arrays, or a single-transducer with an **Integrated Resonating Bar (4)** or **Flow Thru Clamp-On tube (5)**, we can provide standard bath systems or custom solutions that adapt to an existing cleaning or other liquid-treatment process. We offer both fixed frequency systems and wideband frequency systems using our unique MMM technology.

Advantages of our wideband MMM technology include:

- Uniform distribution of ultrasonic energy throughout the bath.
- Wideband frequency modulations create a wide range of cavitation bubble sizes offering faster and more thorough cleaning of parts.
- Complex MMM modulations eliminate standing waves to improve parts cleaning and reduce damaging hot cavitation zones.
- Reduction of standing waves reduces transducer pitting and extends operational life.
- Faster liquid conditioning and degassing of fresh cleaning solutions.
- Adjustable inductive compensation, available on OEM modules, allows simple adaptability to 3rd party transducers and the possibility for field upgrades to existing systems.
- MMM generators can drive multiple high amplitude clamp-on transducers to make unique radial cleaning chambers of any diameter or length.



(1) Bench Top Bath

(2) Submersible Box



(3) Plate Array



(4) Bar Transducer



(5) Flow Thru Clamp

Key Features

- High power solutions to 3,000 watts per Tube Transducer.
- Custom tube lengths (30 cm to 300 cm)



(7) Tube Single-Transducer

Unit Shown has an Active Element Length of 1,200 mm

MMM Tube, Multi-Transducers (8) (Lengths from 30 cm to 200 cm)

Our multi-transducers ultrasonic tubes are constructed to handle very high power for demanding applications. Since they are used exclusively with our Multi-Frequency generators we can construct them to any length (30 cm to 200 cm) to suit your special application.

These transducers are made of high grade stainless steel and generate very high amplitudes uniformly across the entire active surface without standing waves. Their high power and flexible length make them well suited for reactor and cleaning applications.

Key Features

- High power solutions to 3,000 watts per Tube Transducer.
- Custom tube lengths (20 cm to 200 cm)



(8) MMM Tube, Multi-Transducers

Group B): High Intensity, Single-Frequency
Probe Systems: HSPD

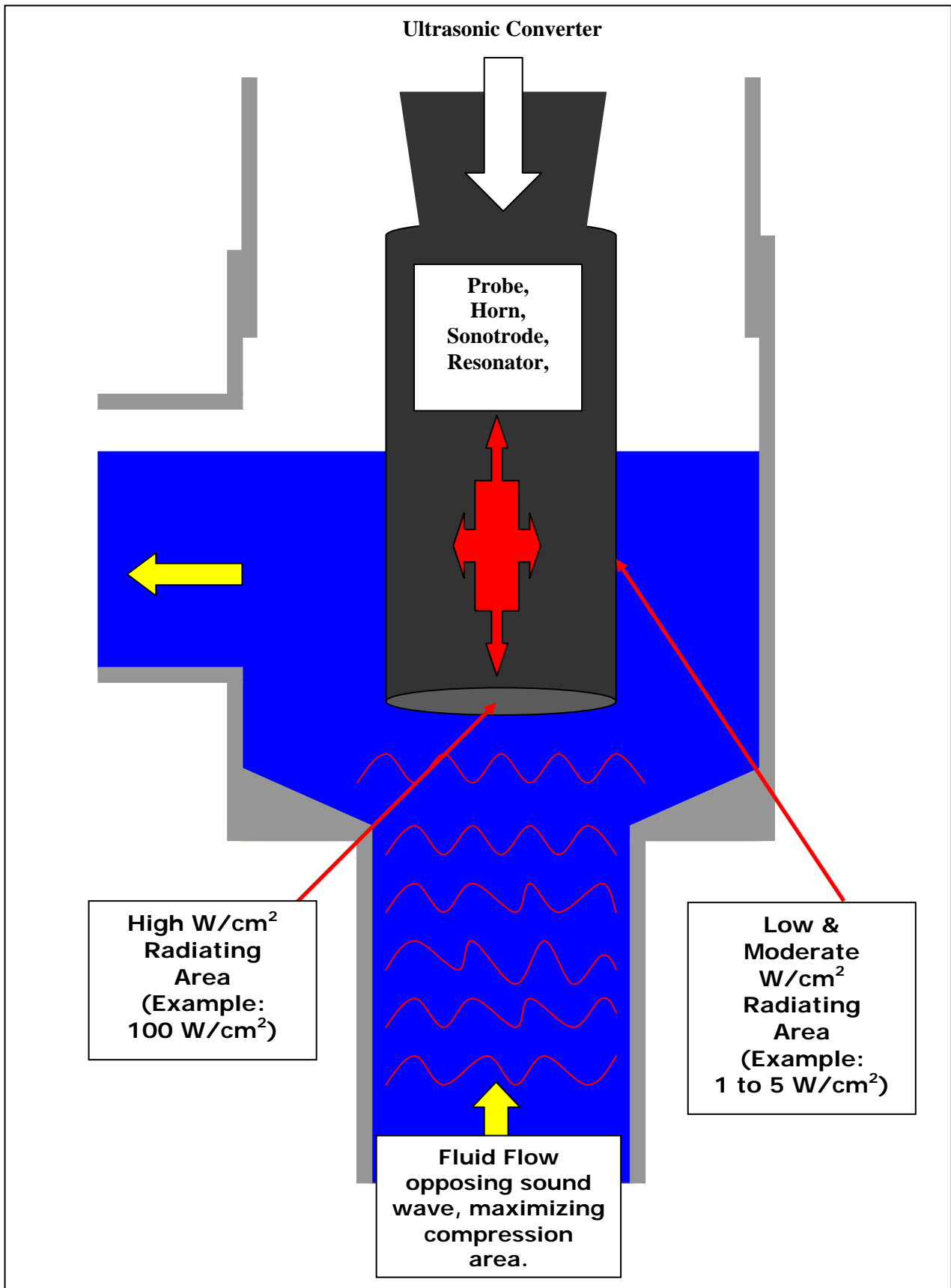

Sonication Chamber Utilizing Fixed Booster Mounting Flange

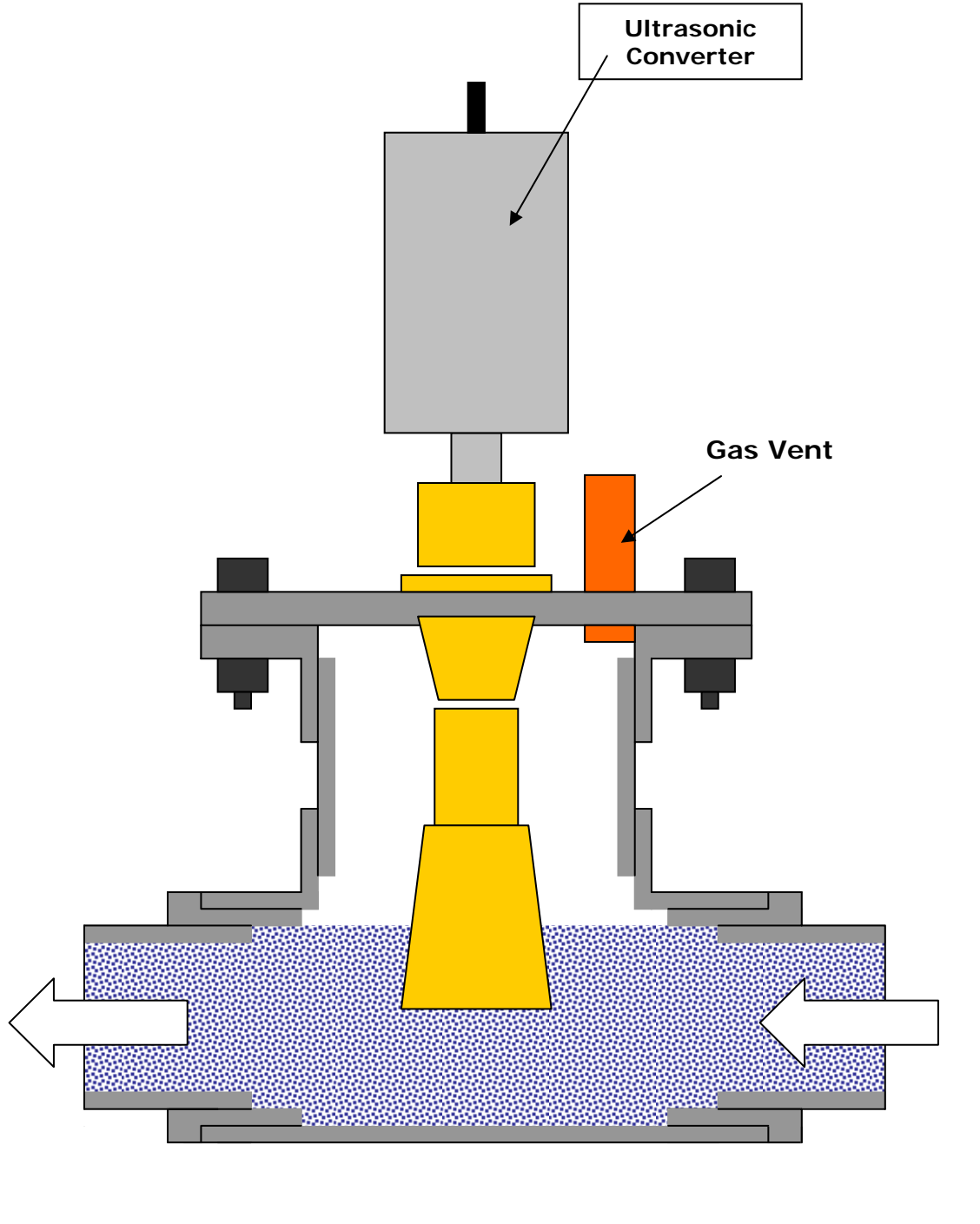

Multiple Converters Sonication Chamber

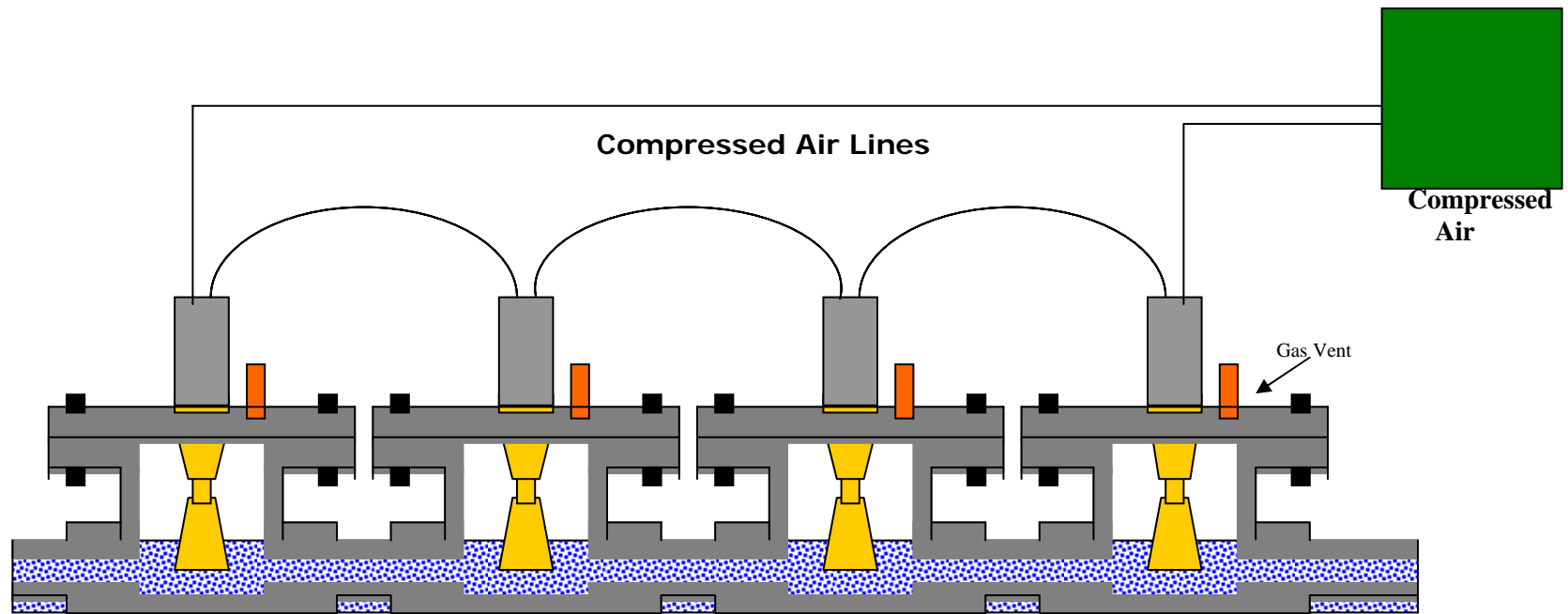

Multiple Converters Sonication Chamber Examples

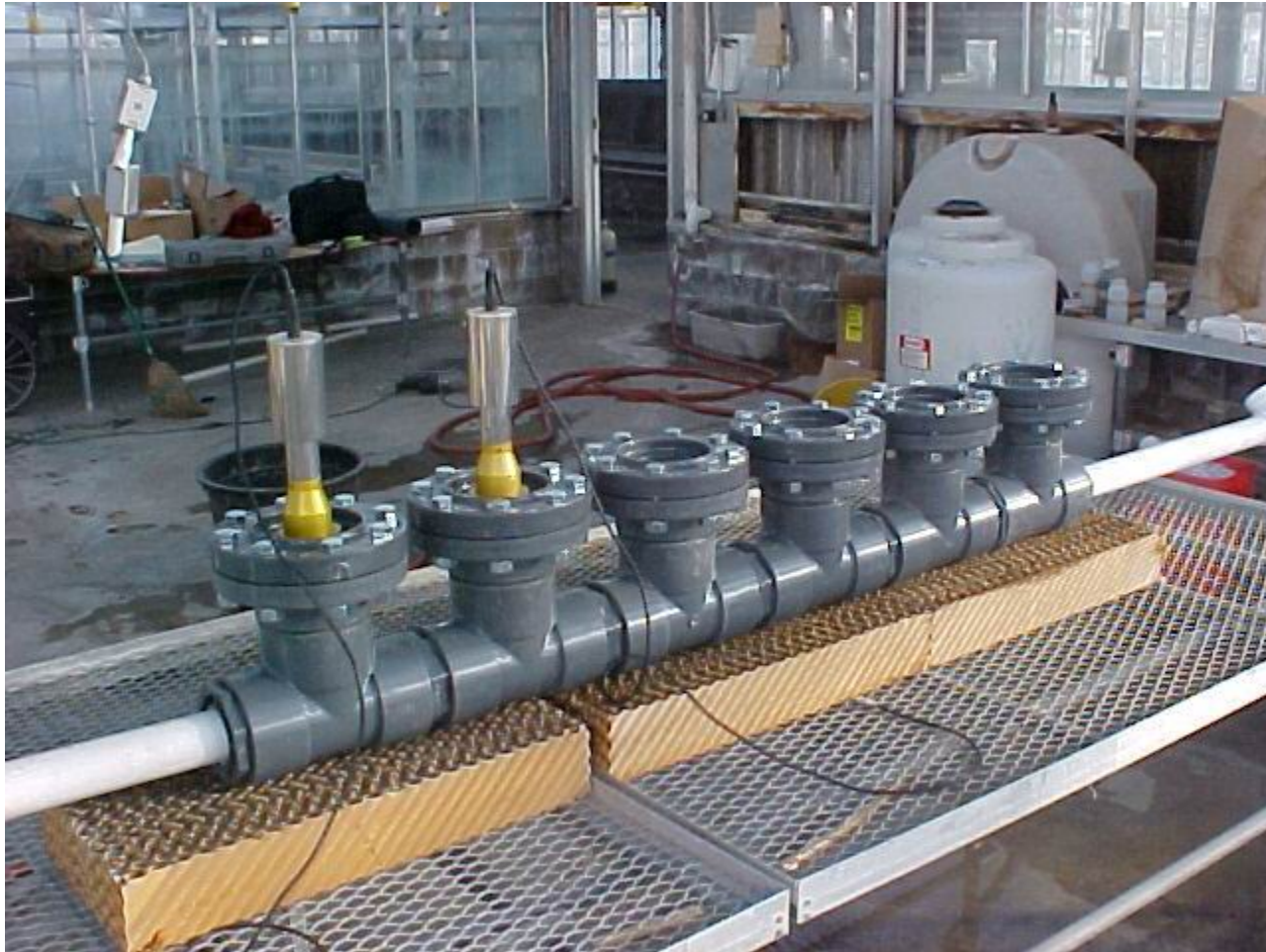

Waste water treatment



Waste water treatment

High Power Fixed-Frequency Piston-Probe

- 20 kHz Fixed frequency
- 2,000 watts max
- Booster Ratio 1:2.0
- Full-wave Probe (titanium)
 - Diameter = 50mm
 - Length = 250 mm
- Very high axial energy produces strong cavitation and acoustic power for mixing, homogenization, flock & particle breakdown.
- New probe design also provides high radial energy for strong cavitation along the probe length.

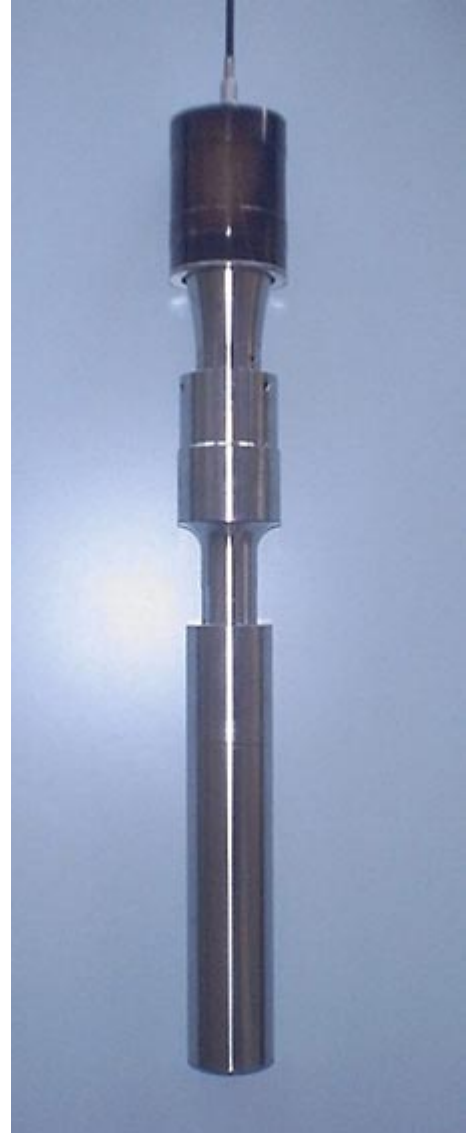

Power Draw Test : In Water		
Probe Submerged	50% Amplitude	100% Amplitude
Full submerge:	1,000 W	1,500 W
½ Submerge:	600 W	1,000 W
½ Submerge:	600 W	1,000 W
¼ Submerge:	300 W	600 W

What to order (minimal order): Converter, Booster, Probe, and Power Supply

20 kHz Fixed frequency
 2,000 watts max
 Booster Ratio 1:2.5
 Fullwave Probe (titanium)
 Diameter = 50mm
 Length = 250 mm

Power Draw Test: In Water

Amplitude at: 50% 100%

Full submerge: 1,000 W 1,500 W

$\frac{3}{4}$ submerge: 1,000 W 1,500 W

$\frac{1}{2}$ Submerge: 1,000 W 1,500 W

$\frac{1}{4}$ Submerge: 1,000 W 1,500 W

Notes:

Good probe radial cavitation shown on sides by aluminum perforation test for 30 seconds.

Good probe radial cavitation shown on bottom by aluminum perforation test for 30 seconds.

Notes:

Good probe radial cavitation shown by visual with hand submersion.



inspection and by feel

Piston Probe Operating in Water

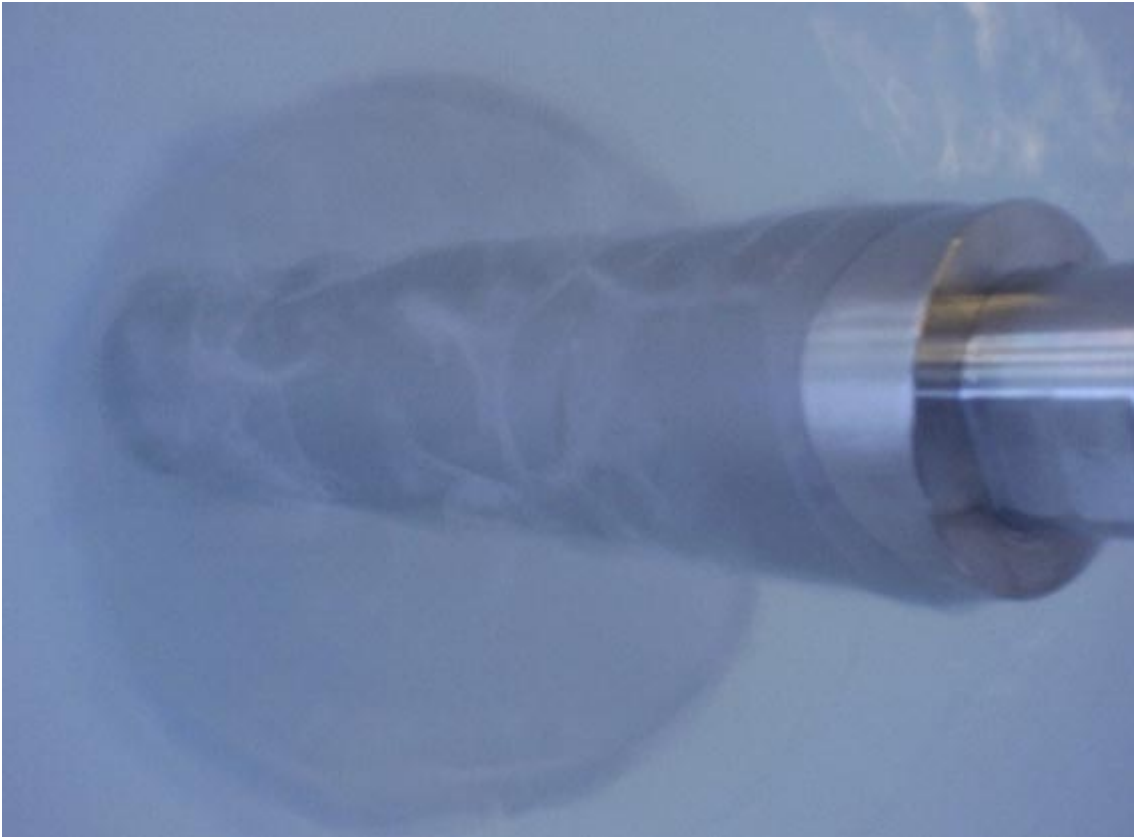

We took a standard fixed frequency generator and converter and tested with a high gain booster (ratio 1:2.5) and a full wave length titanium probe. The probe is about 250 mm (10 inches) in length and 50mm (2 inches) in diameter. Because of the larger diameter we are able to see excellent radial ultrasonic effects in addition to the axial effects on the probe tip.

As is normally done with ultrasonic baths to test for cavitation we did a quick foil test to see if cavitation would penetrate. The results were very good for a 30 second test. This was a slightly thicker foil than normally used so we feel good about the results.

We also see clearly the cavitation areas streaming of the side of the probe. When you immerse your hand in the water you can feel strong cavitation.

This option allows you some good flexibility:

- 1.) You can submerge the probe directly into the treated liquid from an inch up to 9 inches. (You must not submerge above the probe top, this will cause a system overload)
- 2.) We can deliver from low to very high concentrations of power with this system (300 to 1,500 watts). If your liquid load is much denser than water you will draw even more power.
- 3.) You can also change the booster to lower the amplitude (1:2.0 or 1:1.5) or remove the booster to test lower power and amplitude results.
- 4.) We can also discuss optional probe diameters after you have tested in your liquid media. Smaller probes are possible but they will tend to give more axial and less radial energy. Larger probes become difficult to manage with an

unknown liquid density so we need to be careful about larger probes. They may in fact require a special factory set-up that is different from what the 50 mm probe requires.

Piston Sonicator, liquid processing performance: 2000 watt power supply

Amplitude / Power	Booster	Probe Percent Sub-merged	Circular Probe 25 mm diameter 120 mm length Power Output	Circular Probe 38 mm diameter 125 mm length Power Output	Circular Probe 50 mm diameter 125 mm length Power Output
100 %	Titanium 1:2.5	50 %	200 W	640 W	900 W
100 %	Titanium 1:2.5	90 %	300 W	780 W	1200 W

SONIC-digital Acoustic Stack

Transducer (2,000 W)



Best mounting Point



Booster (1:2.5)



Probe (50 mm)



High Surface Power Density Piston-Probe Systems are also available for ultrasonic cleaning applications where it is desirable to deliver extreme or high ultrasonic power to a focused area. Probes may be designed to deliver maximum acoustic power to the tip face where amplitudes are greatest or we can offer probes providing a combination of radial energy along the sides of the probe in addition to high axial power at the end tip face. Probe tip surface power density can be in the range of 10 w/cm² to hundreds of w/cm². This high power ultrasonic energy from the probe tip gives the added benefit of strong acoustic streaming that is directed outward in a straight tight pattern. Advantages in cleaning applications include:

- Intense acoustical pressure at the probe tip generates a combination of ultrasonic cavitation plus strong mixing and streaming liquid currents.
- The strong acoustic streaming energy helps to break apart large flocks and surface contaminants allowing the combined cavitation to further act on smaller particles and exposed surfaces.

Strong acoustic streaming allows cleaning of problematic parts with very small holes or cavities. Gas bubbles trapped in small holes prevent entry of cleaning solution and hinder cleaning. Normal ultrasonic baths that rely only on cavitation may not drive air bubbles from small and long holes. Strong acoustic streaming acts to drive the air bubbles from the void allowing the cleaning solution to enter.

Ultrasonic Power Supplies for above-described single-probe systems are well optimized to deliver very high ultrasonic energy into a liquid load, being fully protected against all accidental and over-loading situations.

Known restrictions related to single-probe systems:

1. **Operating liquid temperature. Necessary to have forced cooling**
2. **Complexity regarding mounting, fixation, sealing**
3. **Sonotrode front-emitting surface-erosion caused by Intensive Cavitation and Sonication**



(After 3 months of operation: 1000 watts, 20 kHz)

Possible applications of single-frequency, high intensity probe systems are:

1. **Mixing and Homogenization of liquids**
2. **Cleaning and surface processing applications (deep holes cleaning)**
3. **Degassing (or gases injection if sonotrode is differently mounted)**
4. **Nano particles technologies**
5. **Accelerated diffusion, filtration**
6. **Extractions**
7. **Sonochemistry**
8. **Accelerated Polymerization (and in some cases de-polymerization)**
9. **Waste waters treatment**
10. **Liquids atomizing**
11. **Surfaces plating, metallization, coating**
12. **Welding...**

Application Example:

Single Probe (single-frequency) Ultrasonic Reactor

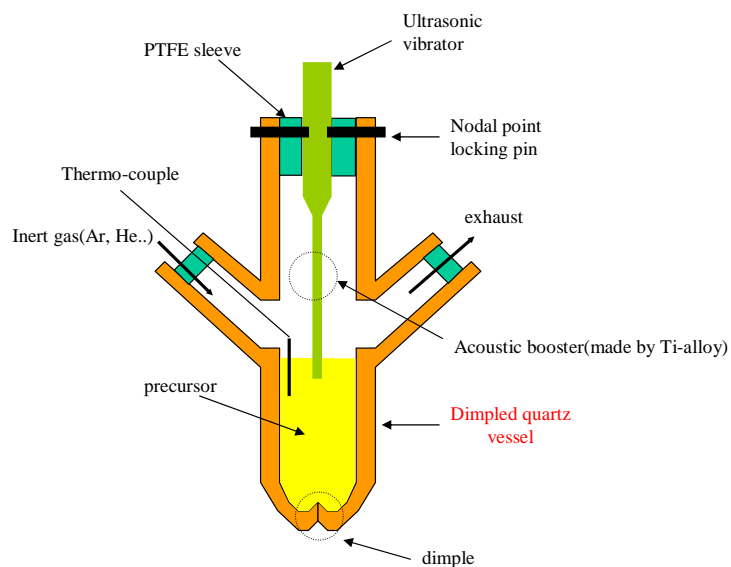

High Power Fixed-Frequency Piston-Probe ULTRASONIC REACTORS

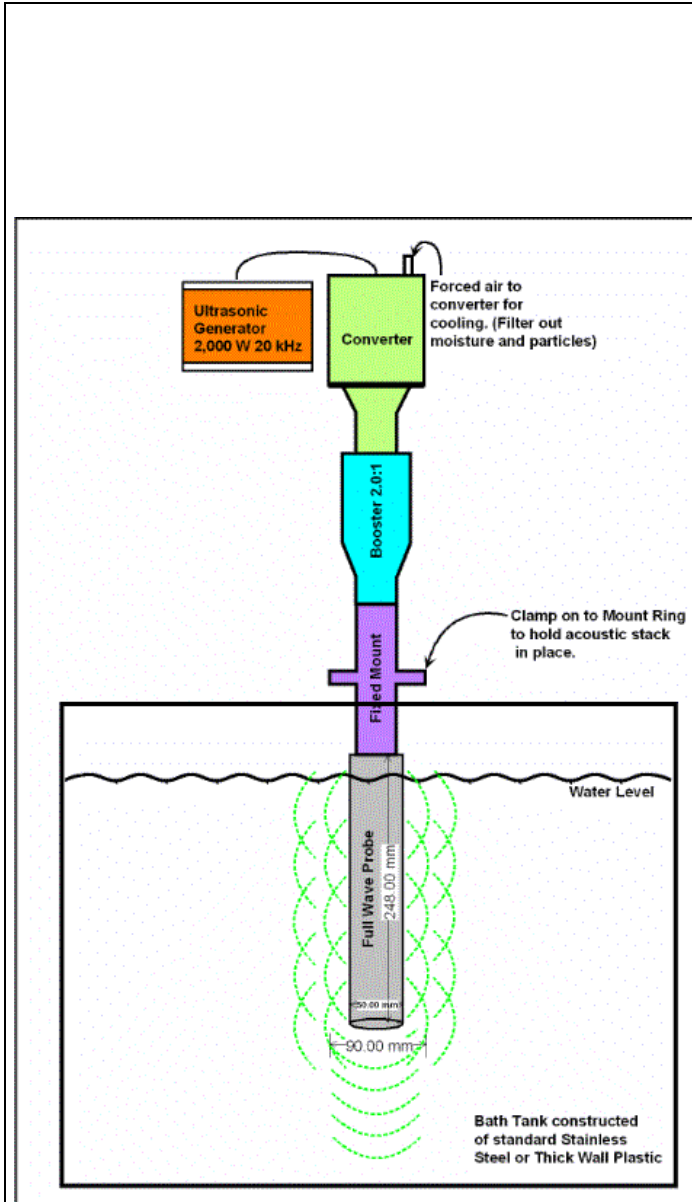

**Option A:
Ultrasonic Bath with
Fixed Frequency Piston Probe**

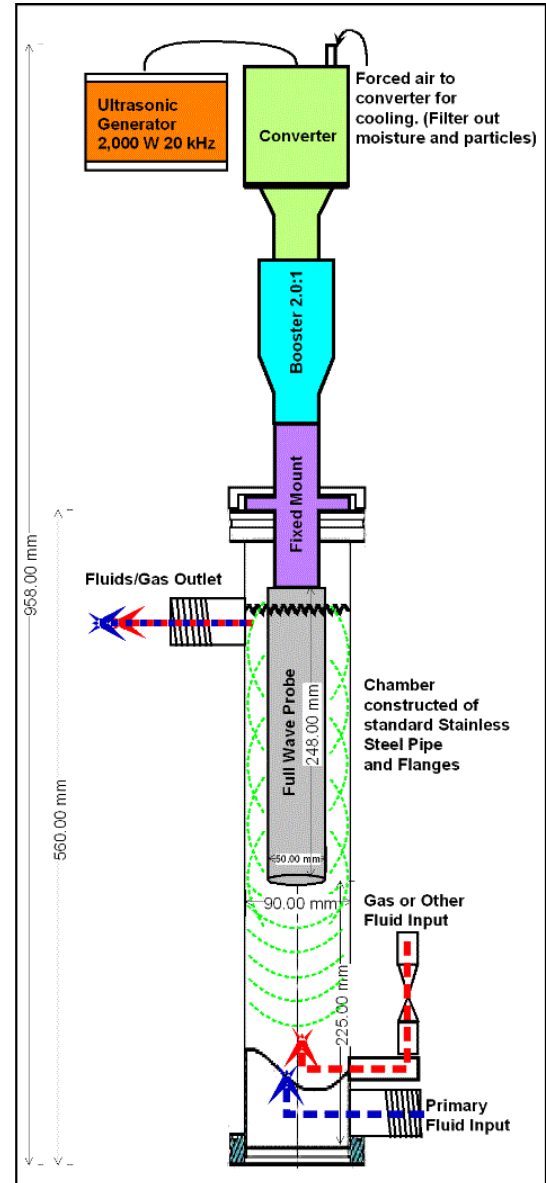

**Option B:
Flow-Thru Chamber with
Fixed Frequency Piston Probe**

High Power Converters for single probe systems

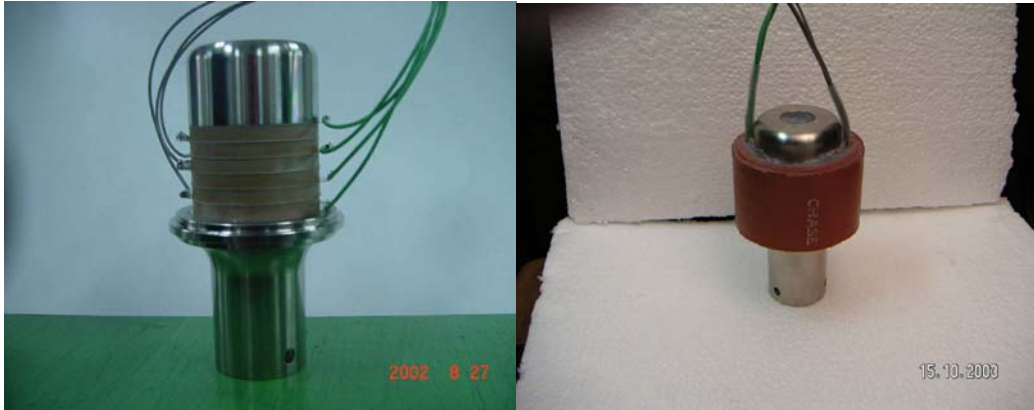

BOOSTERS AND SONOTRODES



Krell Engineering : Industrial Resonators

Industrial resonators deliver high energy density in order to substantially affect the materials with which they are in contact. Common uses include welding of plastics and nonferrous metals, cleaning, abrasive machining of hard materials, cutting, enhancement of chemical reactions (Sonochemistry), liquid processing, defoaming, and atomization. Usual frequencies are between 15 kHz and 40 kHz, although frequencies can range as low as 10 kHz and as high as 100 kHz.

Krell Engineering can design many variations of the resonators shown below. (Note: not all resonators are shown to the same scale.)

A typical industrial ultrasonic stack consists of a [horn](#), [booster](#), and [transducer \(converter\)](#).

 <p data-bbox="370 1680 560 1711">Ultrasonic stack</p>	<p>The horn contacts the load and delivers power to the load. The horn's shape depends on the shape of the load and the required gain. Horns are typically made of titanium, aluminum, and steel. Horns are also called sonotrodes. Small diameter horns are sometimes called probes.</p>
	<p>The booster adjusts the vibrational output from the transducer and transfers the ultrasonic energy to the horn. The booster also generally provides a method for mounting the ultrasonic stack to a support structure.</p>
	<p>The transducer (converter) converts electricity into high frequency mechanical vibration. The active elements are usually piezoelectric ceramics although magnetostrictive materials are also used. Transducers are also called converters.</p>

Horns

Cylindrical horns

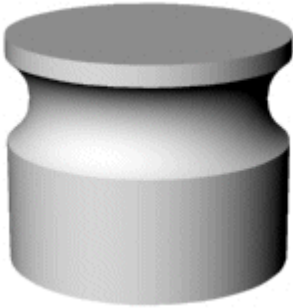
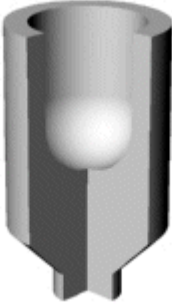
Type	Typical shape	Description
Simple		Solid horns with a simple geometry (stepped, exponential, or catenoidal). May have a replaceable tip. Can have high gain. Used for plastic spot welding and inserting and liquid processing.
Spool		Solid horn with a spool shape and large diameter (up to 1/2 wavelength). Has good amplitude uniformity across the face (generally $\geq 90\%$) and relatively low stress. Face must be flat or have only minor relief. Low gain. Used for plastic welding of circular parts and liquid processing.
Bell	 3/4 section	Unslotted horn with a cavity that extends to the node. Maximum diameter is generally $\leq 0.4 \lambda$. Moderate gain. May have considerable radial face amplitude. Used for plastic welding of circular parts and liquid processing.

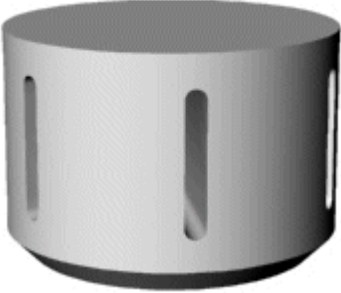
Slotted		<p>Large diameter horn with radial or cross-slots. Diameter usually $\geq 0.4 \times \text{wavelength}$. May have a face cavity. Low gain. Used for plastic welding of circular parts.</p>
---------	---	---

Bar horns

A bar horn has a rectangular output face and is either unslotted or has slots in one direction only. The horn thickness is generally $\leq 0.35 \times \text{wavelength}$.

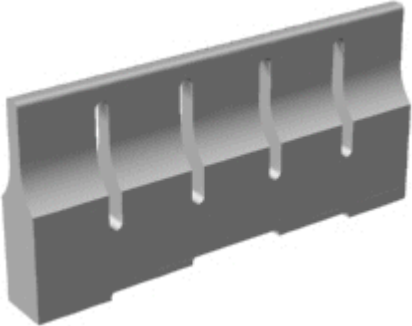

Type	Typical shape	Description
Unslotted		<p>Horn width is generally $\leq 0.4 \times \text{wavelength}$. Moderate gain. Used for plunge and scan welding and for some liquid processing applications (e.g., ultrasonic soldering).</p>
Slotted		<p>Horn width is generally $\geq 0.4 \times \text{wavelength}$. Special design techniques give optimum face amplitude uniformity. Moderate gain. Used for plunge and scan welding.</p>

Block horns

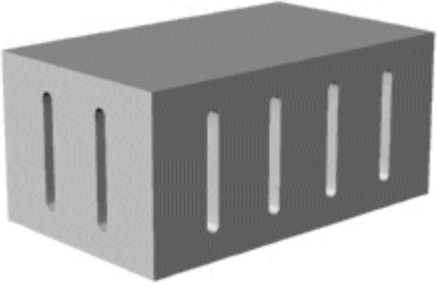

A block horn has a rectangular output face and has slots in two perpendicular directions.

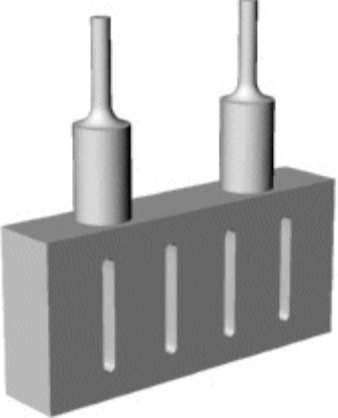
Type	Typical shape	Description
Block		<p>Width and thickness are generally $\geq 0.4 \cdot \text{wavelength}$. Low gain. Used for plastic welding of large, flat, rectangular parts.</p>

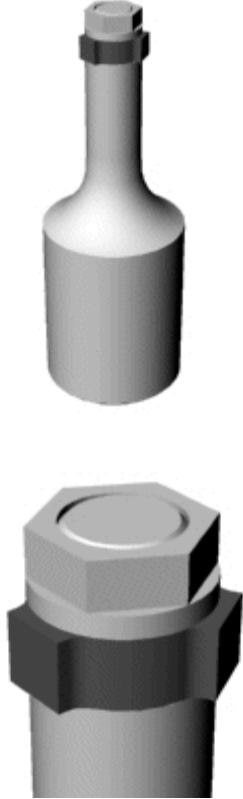

Special horns

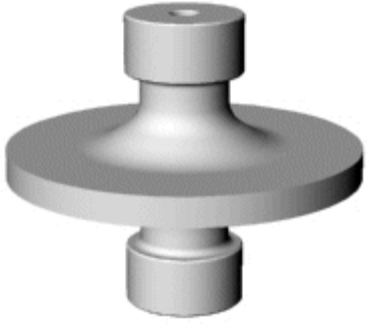
Composite		<p>High gain tip horns are driven by a common mother horn. Used for spot welding of plastics and for liquid processing.</p>
Contoured		<p>A horn that has a complex, often irregular shape machined into its face. Used for plastic welding.</p>

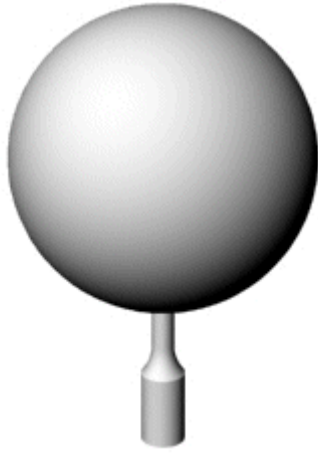
<p>Full-wave bell</p>		<p>This bell horn has an integral booster and is designed for liquid processing. The rigid mount flange provides a hermetic seal against the wall of the pressure vessel.</p>
<p>Metal welding</p>	 <p>Tip and nut details</p>	<p>Metal welding horns have a replaceable annular tip (typically tool steel) that is secured by a nut. The tip has multiple welding lobes.</p>

Radial disk		<p>The resonator is driven axially but the disk vibrates radially. Designed for use with a rigid mount booster. Used for rotary seam welding of plastics.</p>
Flexure disk		<p>The flexure disk is driven axially at its center but vibrates in bending with circular nodes. The amplitude decreases from the center to the edge. Compared to conventional horns, the disk has a large surface area with low mass. With the proper contour, the disk can produce a very narrow, intense acoustic beam. Used primarily for airborne ultrasound (drying, defoaming, agglomeration, etc.).</p>
Radial sphere		<p>The resonator is driven axially but the sphere vibrates with a uniform radial motion. The sphere's diameter is approximately twice the axial half-wavelength (about 250 mm at 20 kHz). Used for atomization and cavitation.</p>

Boosters

Type	Typical shape	Description
O-ring		The mounting ring is isolated from the booster body by O-rings.
Rigid mount		Because the rigid mount booster is constructed only of metal (no compliant elastomers), it has excellent axial and lateral stiffness. For additional stiffness a second mounting ring can be incorporated into a full-wave design. Used with heavy loads or where precise positioning is required and for rotating applications (e.g., seam welding; see radial disk). Also used where a hermetic seal at the mounting ring is required (e.g., for mounting through the wall of a pressure vessel); for an example, see the full-wave bell horn .

Transducers (converters)

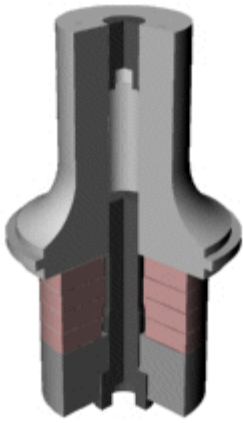
Type	Typical shape	Description
Transducer	 3/4 section	Typical transducer with four piezoelectric ceramics, center-bolt design. The housing and electrode leads are not shown.

Also see [resonator design by finite element analysis](#).